

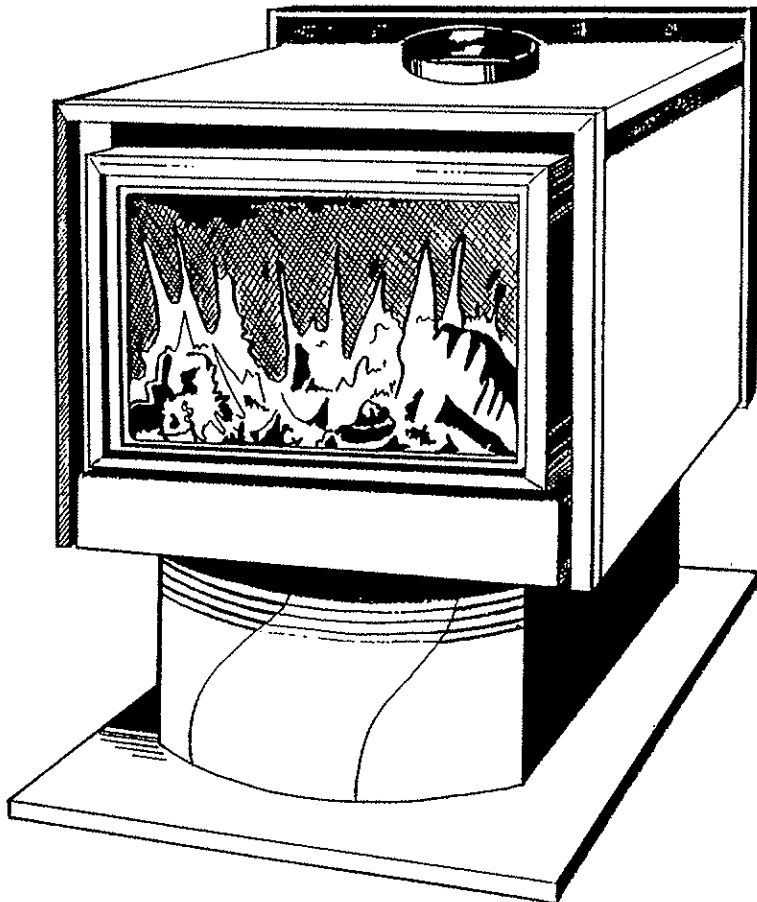

# SPARE PARTS MANUAL





# INDEX

<b>PAGE</b>	
Inside Front Cover .....	INTRODUCTION
1 .....	HANDY HINTS FOR IDENTIFICATION
2 .....	INDEX
3 .....	FLUE KITS LISTING
4 .....	FLUE PARTS LIST
5 .....	ACCESSORIES LISTING
6 .....	GUIDE TO FAN ASSEMBLIES
7 .....	EASY GUIDE TO GRATES
8 .....	DOOR GLASS SIZE GUIDE
9 .....	EASY GUIDE TO FIREBRICKS
10 .....	GUIDE TO BAFFLE PLATES
11 .....	SERIES 1 CAST IRON LINERS"
12 .....	CONVERSION KITS FOR HI-TECHS
13 .....	AIR TRANSFER KITS (TRANSAIR)
14 & 15 .....	CLASSIC COMPACT FREESTANDING AND INBUILT
16 & 17 .....	CLASSIC MEDIUM AND LARGE FREESTANDING MEDIUM AND LARGE INBUILT
18 7 19 .....	PREMIER LARGE FREESTANDER 2
20 & 21 .....	PREMIER MEDIUM FREESTANDER 2
22 & 23 .....	PREMIER LARGE INSERT 2
24 & 25 .....	PREMIER MEDIUM INSERT 2
26 & 27 .....	1200 FREESTANDER SERIES 2
28 & 29 .....	1000 FREESTANDER SERIES 2
30 & 31 .....	2100 INSERT
32 & 33 .....	1900 INSERT
34 & 35 .....	1200 ASHBED
36 & 37 .....	1000 ASHBED
38 & 39 .....	2100 ASHBED
40 & 41 .....	1900 ASHBED
42 & 43 .....	CADET 750
44 & 45 .....	800 FREESTANDER
46 & 47 .....	800 FIREPLACE INSERT
48 & 49 .....	PREMIER LARGE F/S SERIES 1
50 & 51 .....	PREMIER MEDIUM F/S SERIES 1
52 & 53 .....	PREMIER LARGE INSERT SERIES 1
54 & 55 .....	PREMIER MEDIUM INSERT SERIES 1
56 & 57 .....	1600 HIGH TECH. FREESTANDER
58 & 59 .....	1400 HIGH TECH. FREESTANDER
60 & 61 .....	2200 HIGH TECH. INSERT
62 & 63 .....	2000 HIGH TECH. INSERT
64 & 65 .....	2400 SERIES 1 FREESTANDER
66 & 67 .....	1800 SERIES 1 FREESTANDER
68 & 69 .....	2200 SERIES 1 INSERT
70 & 71 .....	2000 SERIES 1 INSERT
72 & 73 .....	1200 SUNSTOVE
74 & 75 .....	1000 SUNSTOVE
76 .....	INBUILT MODELS - EXTENSION PANELS



# FLUE PARTS LISTING

<b>PART NO.</b>	<b>DESCRIPTION</b>
C1000 .....	6" S/S Flue (900mm Length)
C1001 .....	8" S/S Flue (900mm Length)
C1002 .....	9" Galvanised Flue (900mm Length)
C1003 .....	11" Galvanised Flue (900mm Length)
C1023 .....	6" D/S Cowl
C1023H .....	"H" Cowl 6" D/S
C1024 .....	8" D/S Cowl
C1025 .....	6" T/S Cowl
C1025H .....	"H" Cowl 6" T/S
C1106 .....	6" Stainless Tank Offset
C1111 .....	6" Chimney Plate Assembly
C1113 .....	8" Chimney Plate Assembly
C1116 .....	8" — 6" Reducing Tank Offset
C1125 .....	6" Stainless 45 Degree Bend
C1131 .....	9" Galvanised 45 Degree bend
C1132 .....	11" Galvanised 45 Degree bend
C1172 .....	Classic Ceiling Ring — Metallic Warm Brown
C1172BL .....	Classic Ceiling Ring — Black
C1176 .....	Classic Perforated Casing — Metallic Warm Brown
C1177BL .....	Classic Perforated Casing — Black
C1184 .....	Classic 45 Degree Bend Solid — Metallic Warm Brown
C1185BL .....	Classic 45 Degree Bend Solid — Black
C1190 .....	Ceiling Box — Warm Brown Metallic CL/Prem
C1191 .....	Ceiling Box — Black CL
C1194 .....	8" — 6" Reducing Collar
C1209 .....	6" Stainless Steel African Bird Cowl — Anti Down Draught
C1211 .....	Reflective Heat Shield
C1224 .....	Flexi Flue — 2 Metre Length
C1225 .....	Flexi Flue Adaptor
C1254 .....	6" 45 Degree Angle Offset
C1260 .....	6" Wall Penetration Kit
C1280 .....	6" Stainless Steel Length With Aluminium Heatshield
C1285 .....	Floor to Ceiling Penetration Kit (Nominate Colour)
C1286 .....	Flue Restrictor
C1291 .....	Classic Perforated Casing with Heat Shield — Met. Warm Brown
C1292 .....	Classic Perforated Casing with Heat Shield — Black
C1293 .....	Bulk Buy 6" Stainless Steel - (15 x C1000)
C1294 .....	Bulk Buy Flue Parts (6 x C1000 & 6 x C1002 & 6 x C1176/7) (2 Brown, 4 Black)

# ACCESSORIES LISTING

<b>PART NO.</b>	<b>DESCRIPTION</b>
1841 .....	6" Flue Brush (Without Handle)
1842 .....	8" Flue Brush (Without Handle)
1022 .....	Door Rope Seal (Fibreglass) per metre
1021 .....	Glass Tape Seal per metre
3163 .....	Black Aerosol Touch Up Paint
3165 .....	Metallic Warm Brown Aerosol Touch Up Paint
3167 .....	Charcoal Aerosol Touch Up Paint
3169 .....	Leather Brown Aerosol Touch Up Paint
4262 .....	1 Piece Extension Panel Large — Classic Inbuilt
4334 .....	1 Piece Extension Panel Medium — Classic Inbuilt
4173 .....	1 Piece Extension Panel Small — Classic Inbuilt
4174 .....	Small Door Screen Classic
4354 .....	Medium Door Screen Classic
4270 .....	Large Door Screen Classic



# GUIDE TO FAN ASSEMBLIES 1980 - 1995

<b>PART NO.</b>	<b>FAN TYPE</b>	<b>WHERE USED</b>
1930 .....	Twin Barrel Sump .....	Pre 1985 — S1 2000, 2200, 2 Speed
1082 .....	Cassette .....	SR Insert Late S1 Front Loaded
(Available Only for Series 1 Heaters: For Series 2 Use 4012)		All Series 2 Inserts up to 1990 Series 1 Premier Inserts
1500 .....	Barrel .....	Series 2 Freestanders up to 1990 Series 1 Premier Freestanders
1930 .....	Twin Barrel .....	Sunstove 1200 & 1000, 2 Speed
1063 .....	Barrel .....	Series 1 Freestanders 18 & 24
1875 .....	Cassette .....	800 Fireplace Insert Pre April 1992
4158 .....	Barrel small wheel ...	800 Fireplace Insert Post April 1992; 1000A Post April 1992; 1900A Post April 1992
1807 .....	Barrel .....	800 Freestander
4158 .....	Barrel .....	800 Freestander April 1992 on
3025 .....	Cassette .....	PLF-2, PMF-2, PLI-2, PMI-2 and Current CM CL
3010 .....	Speed Control .....	Post 1990 — 1200, 1000, 2100, 1900, 1200A, 2100A, 1900A and 1000A Pre April 1992 plus CM CL
4012 .....	Cassette .....	Fan Conversion Kit to Suit Series 2 Inserts, Series 1 Premier Inserts. Contains Fan Unit and Speed Control Assembly
3327 .....	Mini Duct Fan .....	To Suit Transair Air Transfer Kit
4156 .....	Fan Option Kit	Classic Compact F/S
4158 .....	Fan Only .....	Suit Compact Classic

# EASY GUIDE TO GRATES

Please Check With This Guide Before Ordering Grates  
to Help Avoid Confusion and Delays.

<b>PART NO.</b>	<b>WIDTH</b>	<b>LENGTH</b>	<b>DESCRIPTION</b>	<b>WHERE USED</b>
1153 .....	245mm x 325mm		Left Hand Grate Open End .....	Series 1 1800 / 2000
1152 .....	245mm x 325mm		Right Hand Grate Open End .....	Series 1 1800 / 2000
1157 .....			Set of Grates .....	Series 1 1800 / 2000
1050 .....	310mm x 400mm		Left Hand Grate Open End .....	Series 1 2400 / 2200
1051 .....	310mm x 400mm		Right Hand Grate Open End .....	Series 1 2400 / 2200
1057 .....			Set of Grates .....	Series 1 2400 / 2200
3173 .....	295mm x 260mm		Cast Iron Grate Open End .....	Series 2 1000/1900, 1400 / 2000 — 1986-1988
3172 .....	395mm x 300mm		Cast Iron Grate Open End .....	Series 2 1200 / 2100, 1600 / 2200 — 1986-1988
1973 .....	295mm x 290mm		Cast Iron Grate Solid End .....	Premier Medium Insert 1988 — April 1990
1974 .....	395mm x 335mm		Cast Iron Grate Solid End .....	Premier Large Insert 1988 — April 1990
3031 .....	290mm x 300mm		Cast Iron Grate Solid End .....	Premier Medium Insert, Premier Medium Freestander from May 1990
1265 .....	395mm x 300mm		Cast Iron Grate Solid End .....	Series 2 1200, 2100. PLF 1988 to Current Premier Large Insert May 1990 to Current
1305 .....	290mm x 260mm		Cast Iron Grate Solid End .....	Premier Medium Freestander Series 2 1000, 1900 — 1988 to Current





# EASY GUIDE TO FIREBRICKS

PART NO.	DESCRIPTION
1221	Corner, Series 2 & Post 1991 Premier
1222	Large Rear, 2100, PLI (1), 1600 Hi-Tech, 2200 Hi-Tech
1223	L/H Side, 1600 Hi-Tech, 2200 Hi-Tech, 2100
1224	R/H Side, 1600 Hi-Tech, 2200 Hi-Tech, 2100
1225	Small Rear, 1000, 1900, 2000 & 1400
1226	L/H Side, 1000, 1900, 2000 & 1400
1227	R/H Side, 1000, 1900, 2000 & 1400
1654	L/H Side Series 2 1200
1655	R/H Side Series 2 1200
1840	Rear 1200 & Series 1 PLF
1975	Side (Either) Series 1 PMI
1976	Side (Either) Series 1 PLI
1977	Side (Either) Series 1 PMF
1978	Side (Either) Series 1 PLF
3032	Side & Rear PMF2, PMI2. From Serial No. PMF2 48726, PMI2 48081
3034	Rear PLF2, PLI2 From Serial No. PLF2 45108; PLI2 45424
3035	Corner Premier 1988 - 1990
3295	200mm x 100mm x 25mm — 1000a, 1200a, 1900a, 2100a
3296	100mm x 100mm x 25mm — 1000a, 1900a
3368	200mm x 100mm x 25mm — Chamfered Edge 1000a, 1200a, 1900a, 2100a
3369	100mm x 100mm x 25mm — Chamfered Edge 1000a, 1900a

# GUIDE TO BAFFLE PLATES

## PART NO. DESCRIPTION

### Series 1 Heaters

1347 .....	1000 Sunstove	350mm x 210mm
1333 .....	1200 Sunstove	455mm x 233mm
1143 .....	1800/2000	350mm x 233mm
1027 .....	2400/2200	455mm x 282mm

### Series 2 Heaters

1649 .....	1000, 1900	495mm x 250mm
1650 .....	1200	628mm x 250mm
1693 .....	2100	628mm x 300mm

### Series 2 Ashbeds

3189 .....	1000a, 1900a	520mm x 295mm
3188 .....	1200a, 2100a	628mm x 563mm
3219 .....	Cadet 750	400mm x 300mm
1803 .....	800 & 800fi ➤	457mm x 230mm

### Premier Series 1 (1988 to May 1990)

1649 .....	PMF1, PMI1	495mm x 250mm
1650 .....	PLF1	628mm x 250mm
1693 .....	PLI1	628mm x 300mm

### Premier Series 2 (May 1990 on)

3189 .....	PMF2, PMI2	520mm x 295mm
3188 .....	PLF2, PMF2	628mm x 563mm

### Classic Series

4106 .....	CCF, CCI	425mm x 260mm
4339 .....	CMF, CMI	500mm x 285mm
4266 .....	CLF, CLI	650mm x 260mm
4703 .....	BCF (Nippa)	420mm x 295mm

# SERIES 1 CAST IRON LINERS

PART NO.	DESCRIPTION
1052 .....	Series 1 Large L/H Liner 2400/2200
1053 .....	Series 1 Large R/H Liner 2400/2200
1054 .....	Series 1 Large Rear Liner 2400/2200
1154 .....	Series 1 Small L/H Liner 1800/2000
1155 .....	Series 1 Small R/H Liner 1800/2000
1156 .....	Series 1 Small Rear Liner 1800/2000

**NOTE:** The original Series 1 Heaters had 6 piece, rather than 3 piece Liners. These 6 piece Liners are not available, nor are they compatible with the current 2 piece grates.

The newer 3 piece Liners are stronger and more durable than the original Liners.

If you are replacing the old Liners with the new type it may be necessary to either replace the old grates as well, or modify the existing grates, that is cut out new slots to match the Liners.

1800 / 2000 LINERS

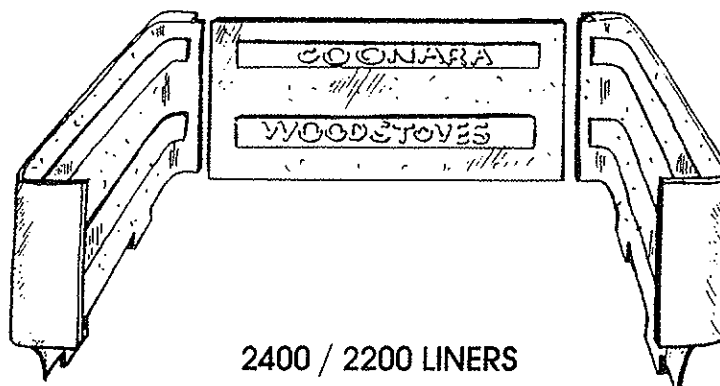
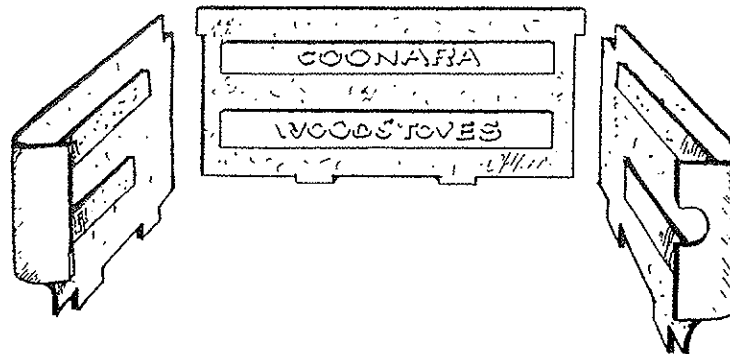

2400 / 2200 LINERS

# HI-TECH. CONVERSION KITS

FOR MODELS 1600, 1400 FREESTANDING & 2000, 2200 FIREPLACE INSERTS

## Fitting Instructions

1. Remove ashpan grate, rear firebrick, corner firebricks then left & right hand firebricks. (DO NOT DISCARD).
2. Remove angled baffle plates (may be cast iron or steel). Discard these plates.
3. Remove the by-pass rod and blanking plate to which the rod is attached. Discard both.
4. Remove the secondary air tube assembly, clean and put aside. Replace the secondary air tube if it is no longer serviceable.
5. Remove flat firebricks from the rear of the firebox and any support channels for the old baffle plates. Discard.
6. Place NEW style rear baffle plate at the rear bottom of the firebox with the tube legs down and facing the rear wall.
7. Fit NEW upper baffle assembly flat side up onto the top of the heat exchanger just under the flue opening.
8. Replace the secondary air tube assembly into its hanging brackets ensuring that the tube section is at the rear with the tube under the plate.
9. Pull the upper baffle plate assembly towards you until it drops and rests in the gap between the heat exchanger and the secondary air tube assembly.
10. Replace firebricks, grate and ashpan.
11. BEFORE lighting a fire, check for correct assembly. Refer to diagram.

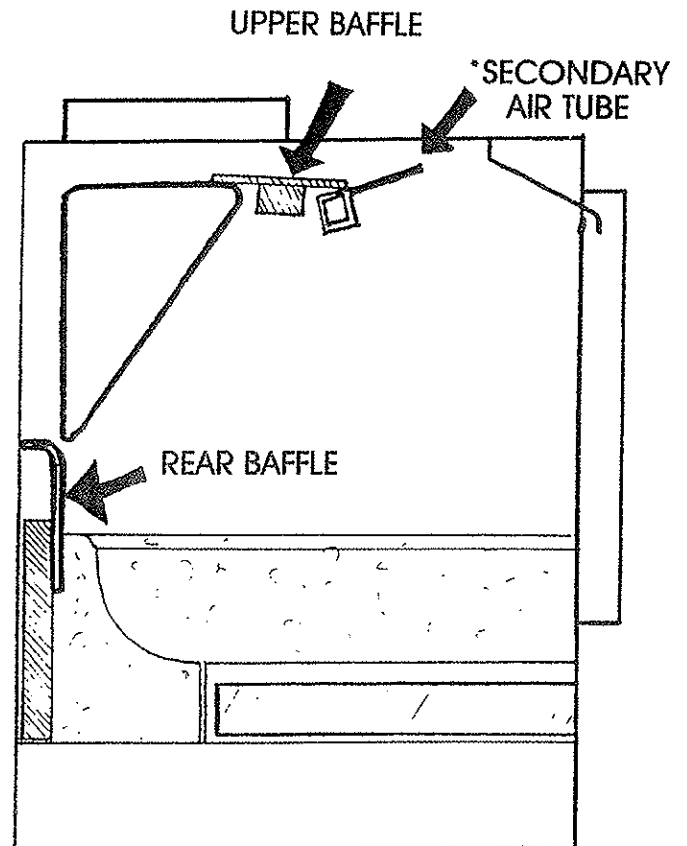

FIREBOX SIDE ELEVATION

## NOTE:

\* When fitting ensure existing Secondary Air Tube Assembly is in good condition.

Conversion Kit consists of Upper and Rear Baffle Assemblies only. Order Secondary Air Tube (if required) as a separate part.

# AIR TRANSFER KITS

PART NO.	DESCRIPTION
3349 .....	Air Transfer Kit
3327 .....	Mini Duct Fan
3324 .....	Round Diffuser
3332 .....	150mm x 6m Insulated Flexi-Duct
3326 .....	Duct Tape
C1259 .....	"Y" Piece
3352 .....	Duct Joiner

## Contents of Air Transfer Kit:

All of the above except for C1259 "Y" Piece and 3352 Duct Joiner.

**Note:** 2 x 3324 Diffusers are included in each kit.

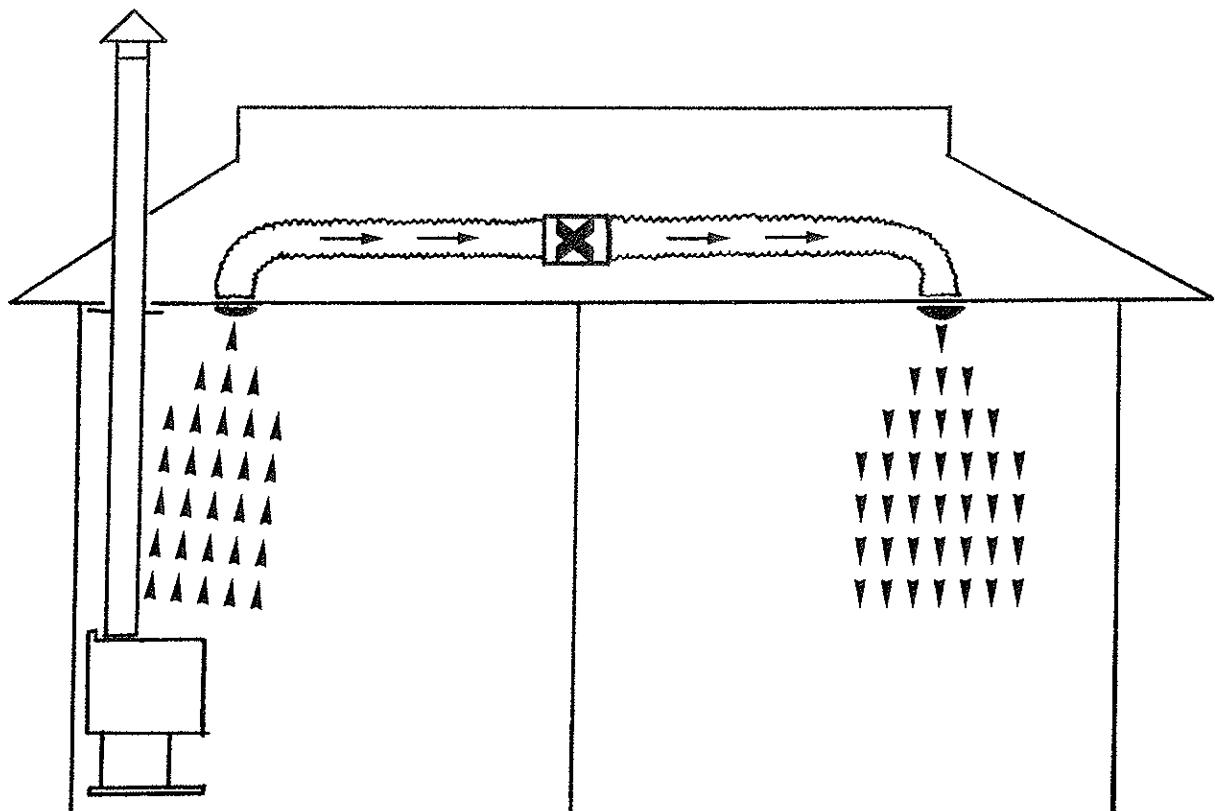

# CLASSIC COMPACT FREESTANDING CLASSIC COMPACT INSERT 1993 — 1995

<b>PART NO.</b>	<b>DESCRIPTION</b>
4106 .....	Baffle Plate Assembly
4153 .....	Air Slide Knob
4159 .....	Door Glass
4145 .....	Door Handle Shaft
4155 .....	Door Handle Knob
1522 .....	Door Handle Engagement Wing
1523 .....	Engagement Wing Spacer
0156 .....	Lock Nut $\frac{3}{8}$ Whitworth (All)
1574 .....	Door Catch
4174 .....	Mesh Door Screen (10mm Screws Provided)
4156 .....	Optional Fan Kit
4158 .....	Fan Only
4250 .....	In-Line Switch Assembly

**COMPLETE PARTS DIAGRAM OPPOSITE**

BAFFLE ASSEMBLY

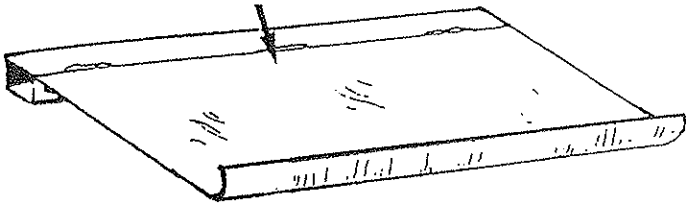

AIR SLIDE KNOB

DOOR HANDLE SHAFT

DOOR HANDLE KNOB

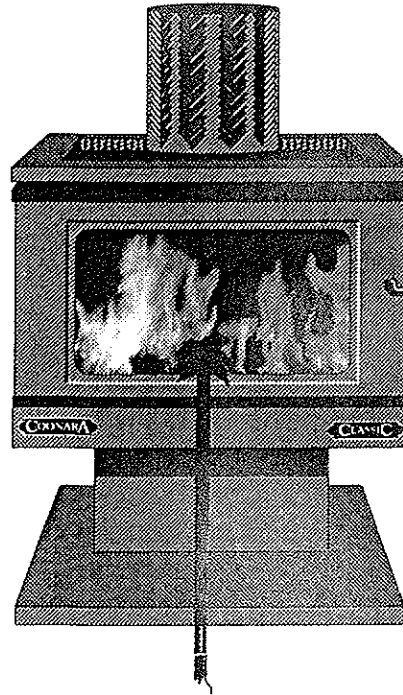

DOOR GLASS

AIR SLIDE KNOB

DOOR HANDLE SHAFT

DOOR HANDLE KNOB

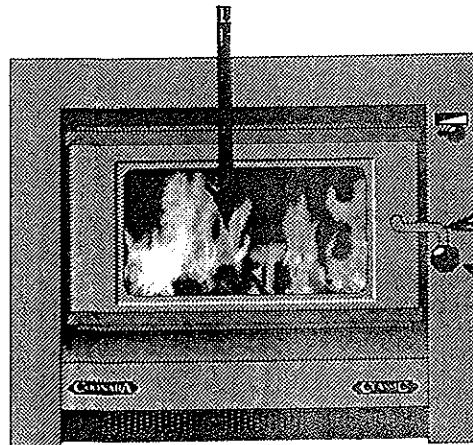

IN-LINE SWITCH ASSEMBLY

LOCK NUT

SPACERS

ENGAGEMENT WING

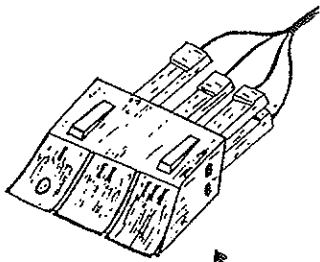

FAN ASSEMBLY

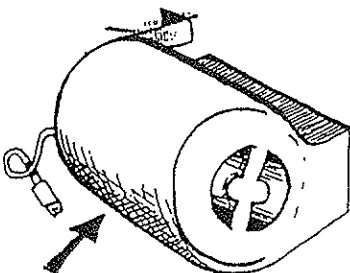

DOOR CATCH





# CLASSIC MEDIUM & LARGE FREESTANDING CLASSIC MEDIUM & LARGE INSERT 1993 – 1995

**PART NO.                      DESCRIPTION**

**SERIES 2**

4339 .....	Baffle Plate Assembly CMF / CMI
4266 .....	Baffle Plate Assembly CLF / CLI
4153 .....	Air Slide Knob (All)
4160 .....	Door Glass CMF / CMI
4161 .....	Door Glass CLF / CLI
4242 .....	Door Handle (All)
4243 .....	Door Handle Shaft (All)
4245 .....	Door Handle Bolt (All)
1522 .....	Engagement Wing (All)
1523 .....	Engagement Wing Spacer (3 Required) (All)
0156 .....	Lock Nut $\frac{3}{8}$ Whitworth (All)
4236 .....	Door Handle Stop Washer (All)
4244 .....	Door Handle Spacer (All)
1574 .....	Door Catch (All)
3010 .....	Speed Control Assembly (All)
3025 .....	Fan Assembly (All)
4250 .....	In-Line Switch Assembly (All)
4270 .....	Large Door Screen (10mm Screws Provided)
4354 .....	Medium Door Screen (10mm Screws Provided)

**COMPLETE PARTS DIAGRAM OPPOSITE**

BAFFLE ASSEMBLY

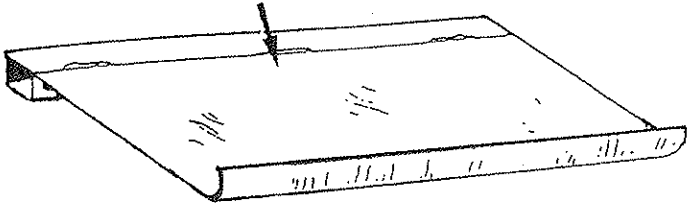

FAN ASSEMBLY

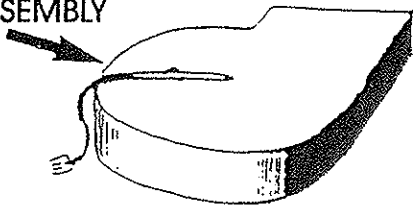

AIR SLIDE KNOB

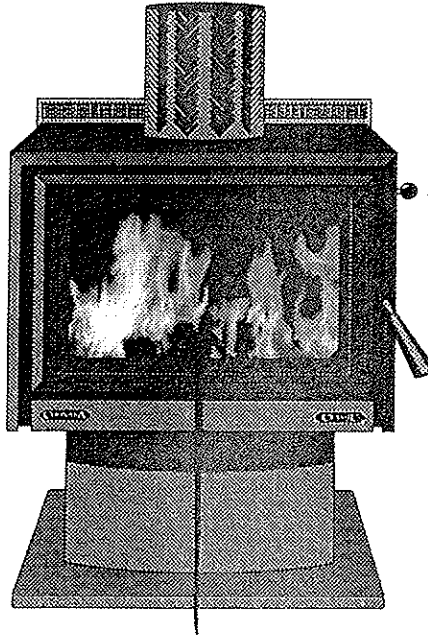

DOOR GLASS

AIR SLIDE KNOB

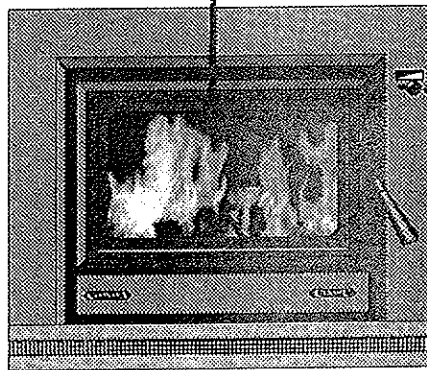

SPEED CONTROL ASSEMBLY

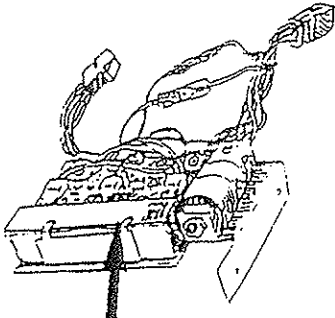

IN-LINE SWITCH ASSEMBLY

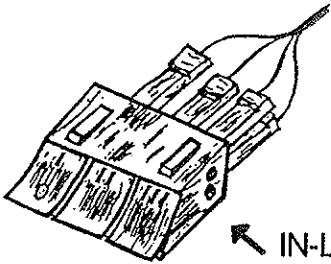

DOOR HANDLE SPACER



DOOR CATCH

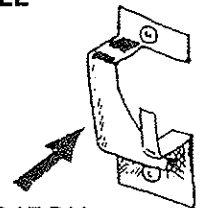

DOOR HANDLE STOP WASHER



LOCK NUT



SPACERS



DOOR HANDLE SHAFT



ENGAGEMENT WING



DOOR HANDLE BOLT



WOODEN DOOR HANDLE



# PREMIER LARGE FREESTANDER 2 1990 – 1995

<b>PART NO.</b>	<b>DESCRIPTION</b>
0026 .....	3 Speed Rotary Switch
3188 .....	Baffle Assembly
1265 .....	Grate
1221 .....	Corner Firebrick
3032 .....	L/H and R/H Firebricks
3034 .....	Rear Firebrick
3025 .....	Fan Assembly
3010 .....	Speed Control Assembly
3011 .....	Fan and Motor (Less Housing)
1971 .....	Door Glass
1467 .....	Ash Door Handle
1574 .....	Door Catch
2106 .....	Wooden Airslide Handle
2096 .....	Door Handle Shaft
1522 .....	Handle Engagement Wing
0156 .....	Handle Locknut
1998 .....	Wooden Door Handle
1243 .....	Ashpan
3119 .....	Pedestal Trim
2149 .....	Coonara Badge Assembly
4007 .....	Complete Ash Door Assembly
1465 .....	Ash Door Engagement Wing
2263 .....	Mesh Door Screen

**COMPLETE PARTS DIAGRAM OPPOSITE**

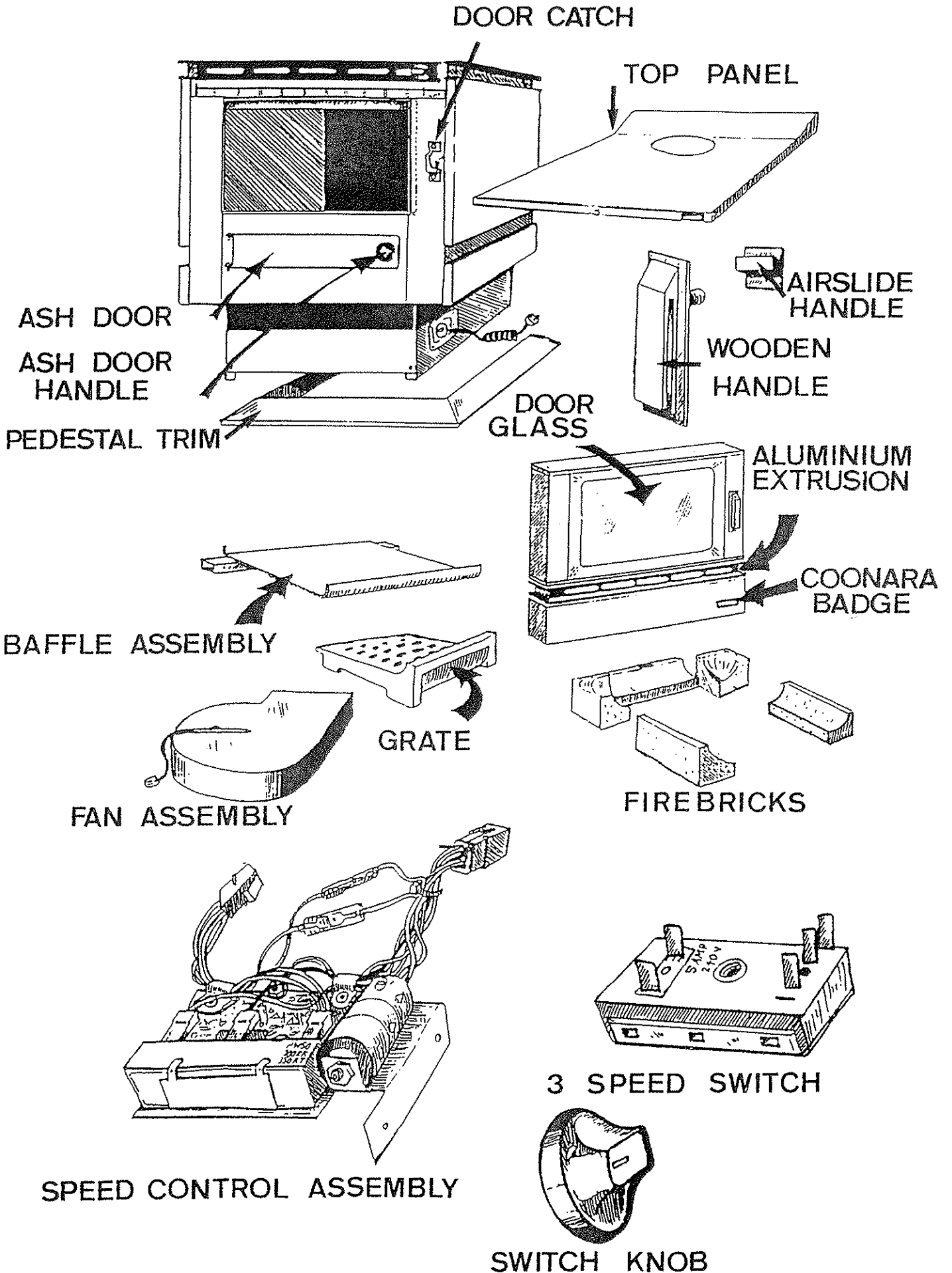

# PREMIER MEDIUM FREESTANDER 2

## 1990 — 1995

<b>PART NO.</b>	<b>DESCRIPTION</b>
0026 .....	3 Speed Rotary Switch
3189 .....	Baffle Assembly
3031 .....	Grate
1221 .....	Corner Firebrick
3032 .....	L/H and R/H Firebricks
3032 .....	Rear Firebrick (See Guide to Firebricks Page 9)
3025 .....	Fan Assembly
3010 .....	Speed Control Assembly
3011 .....	Fan and Motor (Less Housing)
1969 .....	Door Glass
1467 .....	Ash Door Handle
1574 .....	Door Catch
2106 .....	Wooden Airslide Handle
2096 .....	Door Handle Shaft
1522 .....	Handle Engagement Wing
0156 .....	Handle Locknut
1998 .....	Wooden Door Handle
1285 .....	Ashpan
3119 .....	Pedestal Trim
2149 .....	Coonara Badge Assembly
4027 .....	Complete Ash Door Assembly
1465 .....	Ash Door Engagement Wing
2262 .....	Mesh Door Screen

**COMPLETE PARTS DIAGRAM OPPOSITE**

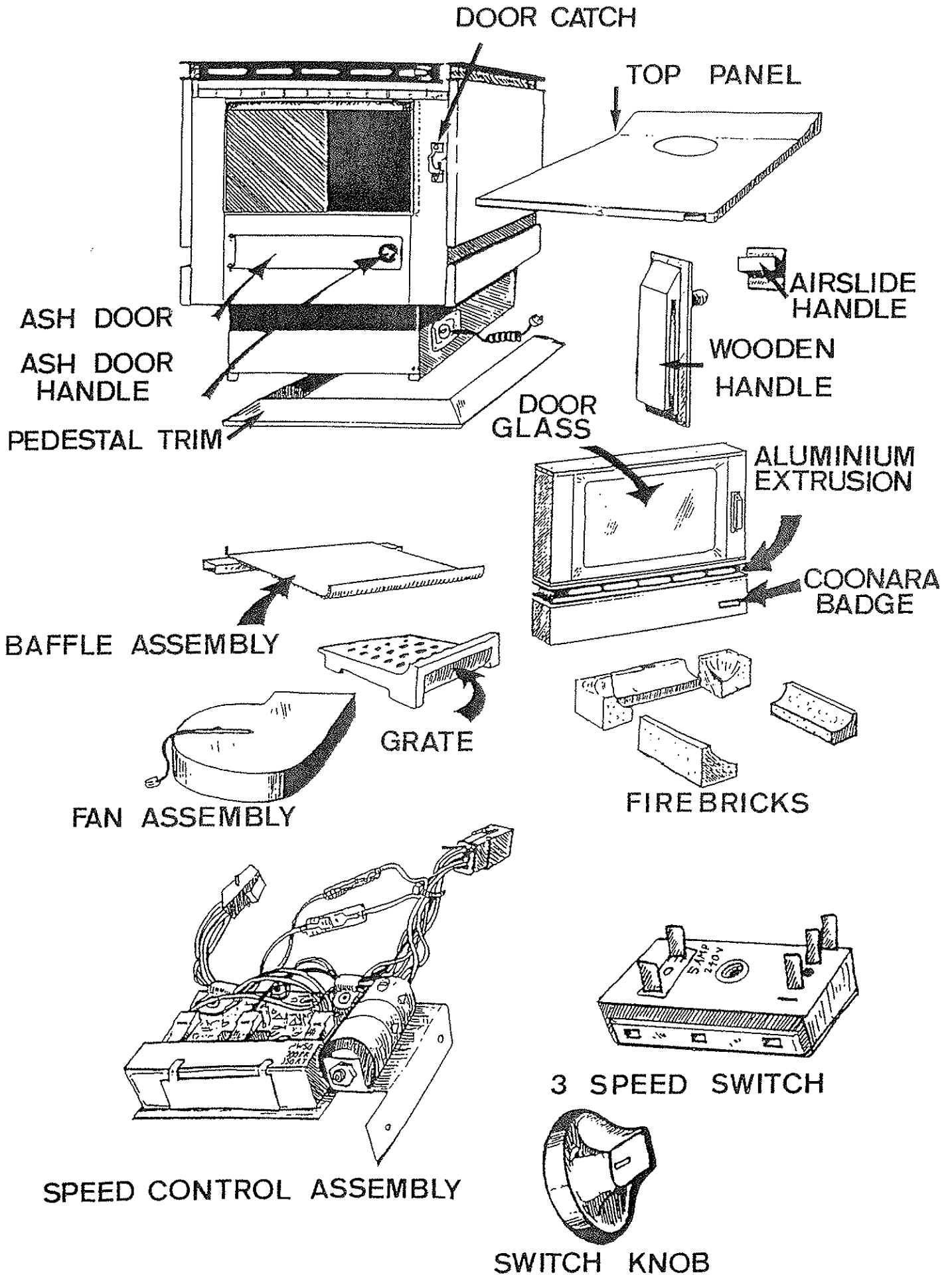

# PREMIER LARGE INSERT 2

## 1990 — 1995

PART NO.	DESCRIPTION
0026 .....	3 Speed Rotary Switch
3188 .....	Baffle Assembly
1265 .....	Grate
1221 .....	Corner Firebrick
1976 .....	L/H and R/H Firebricks
3034 .....	Rear Firebrick
3025 .....	Fan Assembly
3010 .....	Speed Control Assembly
3011 .....	Fan and Motor (Less Housing)
1971 .....	Door Glass
1467 .....	Ash Door Handle
2093 .....	Door Catch
2106 .....	Wooden Airslide Handle
2091 .....	Door Handle Shaft
2092 .....	Door Handle Hook
0156 .....	Handle Locknut
1998 .....	Wooden Door Handle
1243 .....	Ashpan
0113 .....	Touch Catch
0115 .....	Touch Catch Keeper
2149 .....	Coonara Badge Assembly
4046 .....	Complete Ash Door Assembly
1465 .....	Ash Door Engagement Wing
2263 .....	Mesh Door Screen

**COMPLETE PARTS DIAGRAM OPPOSITE**

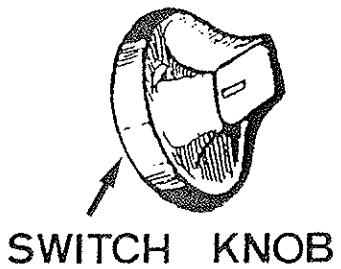
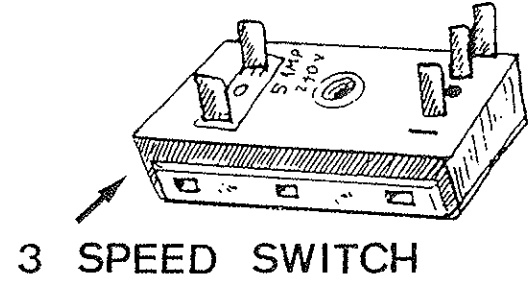
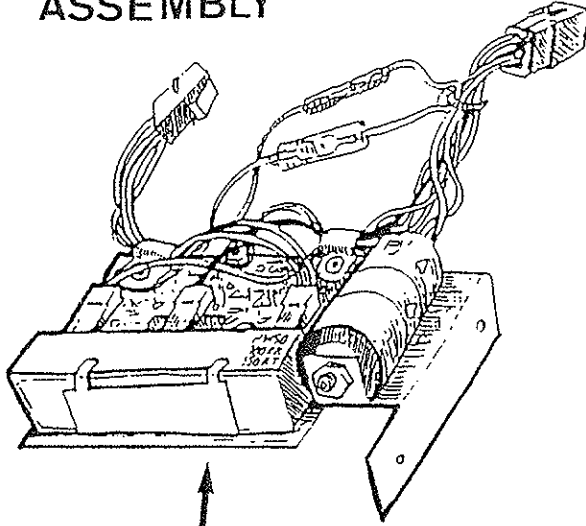
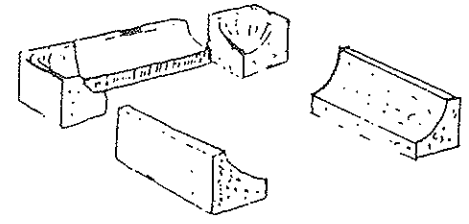
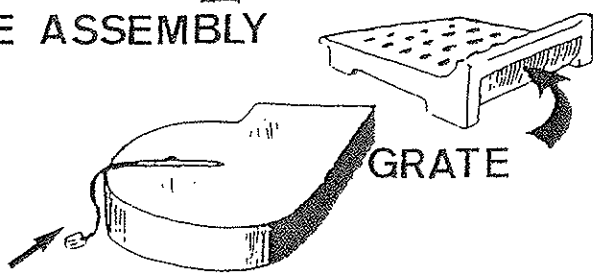
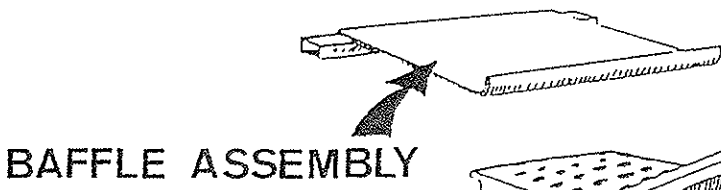
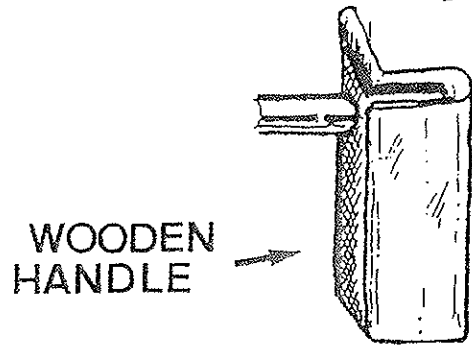
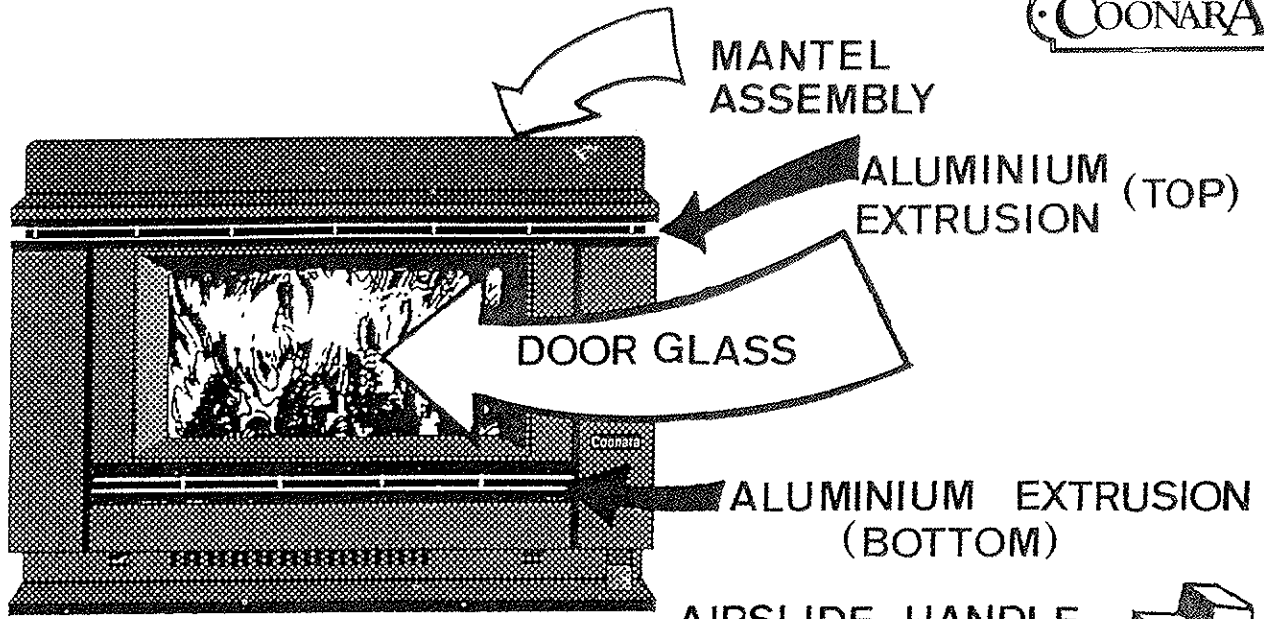



# PREMIER MEDIUM INSERT 2

## 1990 — 1993

PART NO.	DESCRIPTION
0026 .....	3 Speed Rotary Switch
3189 .....	Baffle Assembly
3031 .....	Grate
1221 .....	Corner Firebrick
3032 .....	L/H and R/H Firebricks
3032 .....	Rear Firebrick
3025 .....	Fan Assembly
3010 .....	Speed Control Assembly
3011 .....	Fan and Motor (Less Housing)
1969 .....	Door Glass
1467 .....	Ash Door Handle
2093 .....	Door Catch
2106 .....	Wooden Airslide Handle
2091 .....	Door Handle Shaft
2092 .....	Door Handle Hook
0156 .....	Handle Locknut
1998 .....	Wooden Door Handle
1285 .....	Ashpan
0113 .....	Touch Latch
0115 .....	Touch Latch Keeper
2149 .....	Coonara Badge Assembly
4066 .....	Complete Ash Door Assembly
1465 .....	Ash Door Engagement Wing
2262 .....	Mesh Door Screen

**COMPLETE PARTS DIAGRAM OPPOSITE**

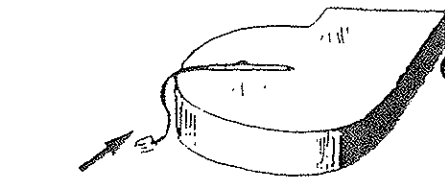
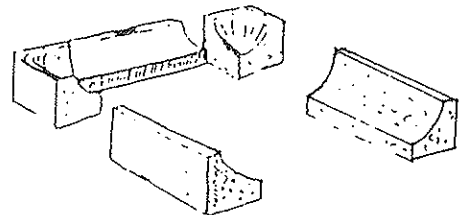
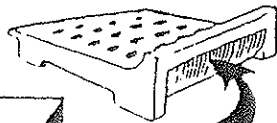
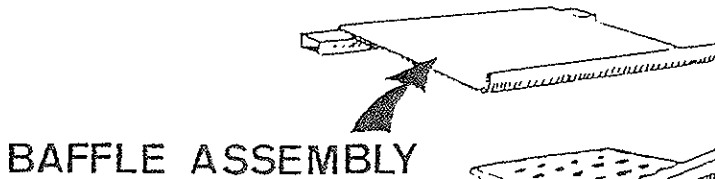
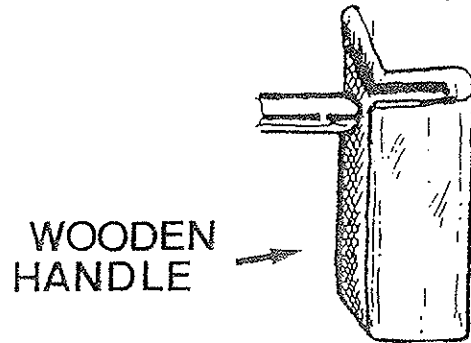
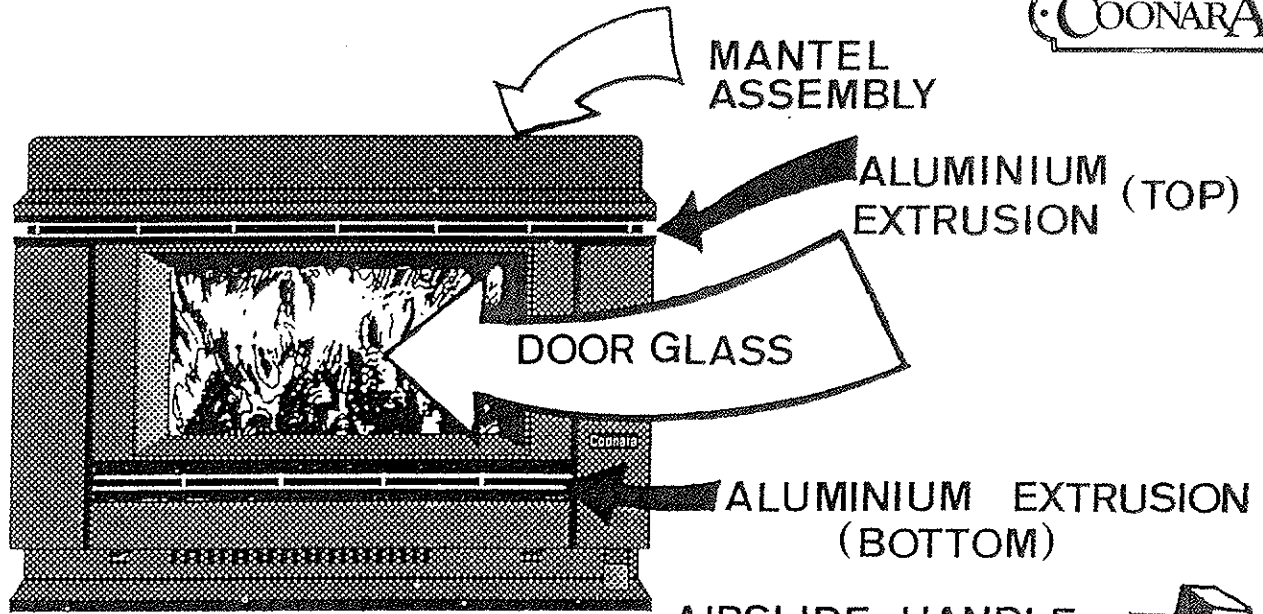

FAN ASSEMBLY

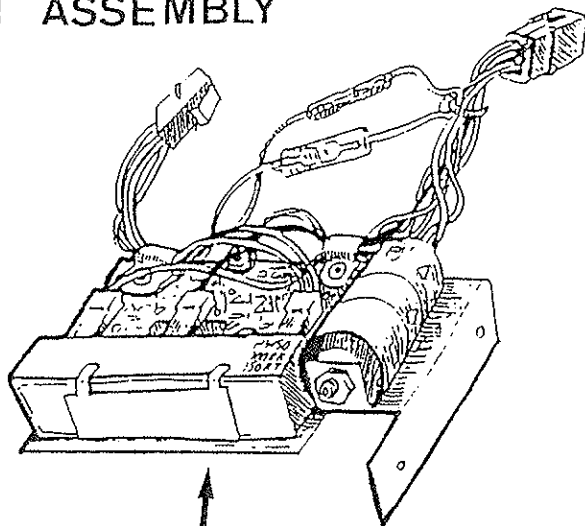

SPEED CONTROL ASSEMBLY

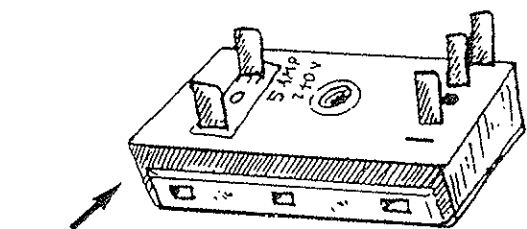

3 SPEED SWITCH

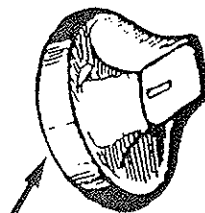

SWITCH KNOB

# 1200 CLASSIC FREESTANDER 1986 — 1995

<b>PART NO.</b>	<b>DESCRIPTION</b>
0026 .....	3 Speed Rotary Switch
1650 .....	Baffle Plate Assembly
1265/3172* .....	Grate*** (See Footnote)
1500/3025* .....	Fan Assembly*** (See Footnote)
3010 .....	Speed Control Assembly (Post 1990 Only)
1221 .....	Corner Firebrick
1654 .....	Left Hand Firebrick
1655 .....	Right Hand Firebrick
1840 .....	Rear Firebrick
1134 .....	Door Glass
1574 .....	Door Catch
1472 .....	Wooden Airslide Handle
1518 .....	Door Handle Shaft
1522 .....	Handle Engagement Wing
0156 .....	Handle Locknut
1660 .....	Wooden Door Handle
1661 .....	Door Handle Bolt
1378 BR .....	Ash Flap Fashion Panel Brown
1378 RD .....	Ash Flap Fashion Panel Red
1378 GR .....	Ash Flap Fashion Panel Grey
1533 BR .....	Side Fashion Panel Brown
1533 RD .....	Side Fashion Panel Red
1533 GR .....	Side Fashion Panel Grey
1243 .....	Ash Pan
1467 .....	Ash Door Handle
1499 .....	Wooden Ash Flap Handle
1131 .....	Inner Door Pan
3119 .....	Pedestal Trim (Post 1990 Only)
1493 .....	Complete Ash Door Assembly
1611 .....	Complete Switch Assembly (Including Plug and Loom)

**\*\*\*NOTE:**

Pre 1988, the Grate used was P.N.3172. Post 1988, the Grate is 1265.  
Also pre 1990, the Fan was A1500. Post 1990 the Fan is the new 3025.

**NOTE:**

Check availability of Glass Panels before ordering

**COMPLETE PARTS DIAGRAM OPPOSITE**

BAFFLE ASSEMBLY

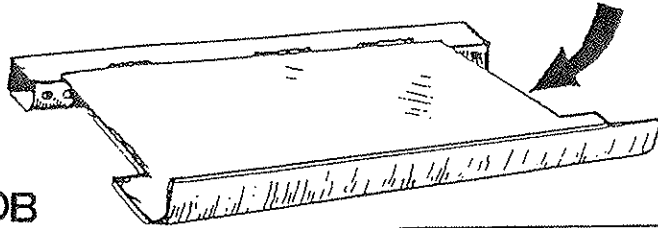

ASH DOOR KNOB

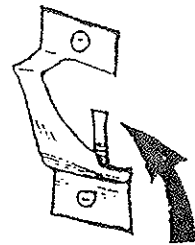

SWITCH KNOB



SWITCH

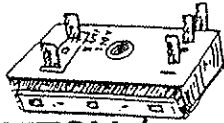

ASH DOOR



DOOR CATCH

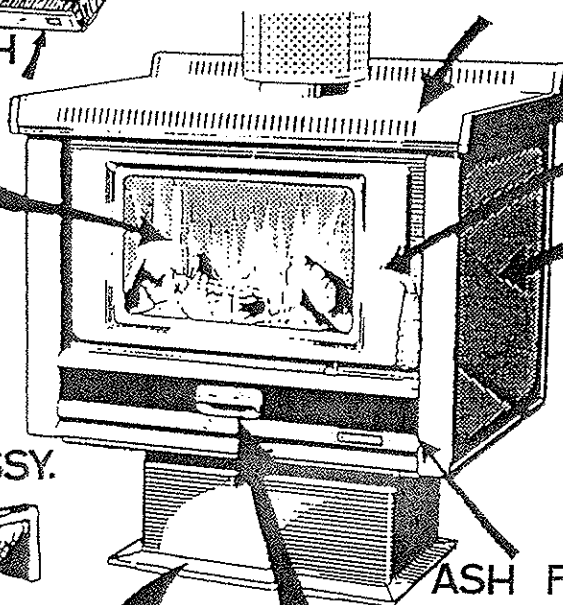

SIDE FASHION PANEL



AIRSLIDE HANDLE

SPEED CONTROL ASSY.

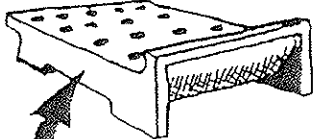
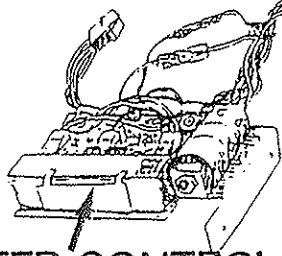

GRATE

PEDESTAL TRIM



ASH FLAP FASHION PANEL

ASH FLAP HANDLE

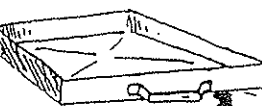

ASHPAN

FAN ASSEMBLY

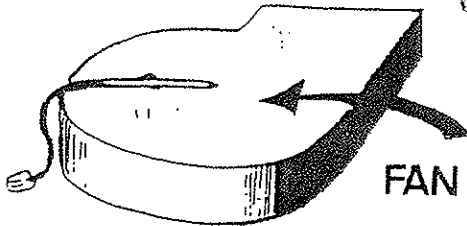

CORNER FIREBRICK

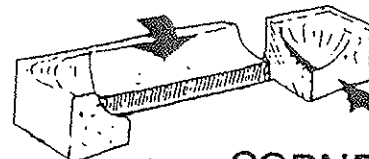

LEFT HAND FIREBRICK

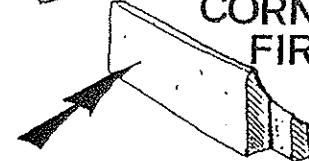

RIGHT HAND FIREBRICK

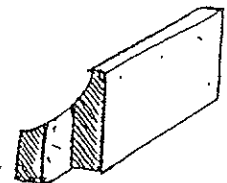

DOOR HANDLE ASSEMBLY

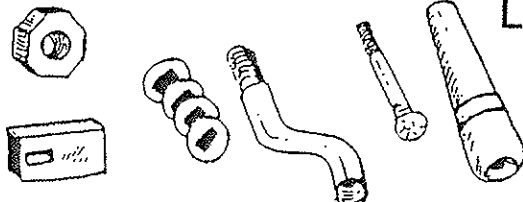

# 1000 CLASSIC FREESTANDER

## 1986 — 1995

<b>PART NO.</b>	<b>DESCRIPTION</b>
0026 .....	3 Speed Rotary Switch
1649 .....	Baffle Plate Assembly
1305/3173* .....	Grate*** (See Footnote)
1500/3025* .....	Fan Assembly*** (See Footnote)
3010 .....	Speed Control Assembly (Post 1990 Only)
1221 .....	Corner Firebrick
1226 .....	Left Hand Firebrick
1227 .....	Right Hand Firebrick
1225 .....	Rear Firebrick
1138 .....	Door Glass
1574 .....	Door Catch
1472 .....	Wooden Airlide Handle
1518 .....	Door Handle Shaft
1522 .....	Handle Engagement Wing
0156 .....	Handle Locknut
1660 .....	Wooden Door Handle
1661 .....	Door Handle Bolt
1377 BR .....	Ash Flap Fashion Panel Brown
1377 RD .....	Ash Flap Fashion Panel Red
1377 GR .....	Ash Flap Fashion Panel Grey
1532 BR .....	Side Fashion Panel Brown
1532 RD .....	Side Fashion Panel Red
1532 GR .....	Side Fashion Panel Grey
1285 .....	Ash Pan
1467 .....	Ash Door Handle
1499 .....	Wooden Ash Flap Handle
1136 .....	Inner Door Pan
3119 .....	Pedestal Trim (Post 1990 Only)
1494 .....	Complete Ash Door Assembly
1611 .....	Complete Switch Assembly (Including Plug and Loom)

**\*\*\*NOTE:**

Pre 1988, the Grate used was P.N.3173. Post 1988, the Grate is 1305.  
 Also pre 1990, the Fan was A1500. Post 1990 the Fan is the new 3025.

**NOTE:**

Check availability of Glass Panels before ordering

**COMPLETE PARTS DIAGRAM OPPOSITE**

BAFFLE ASSEMBLY

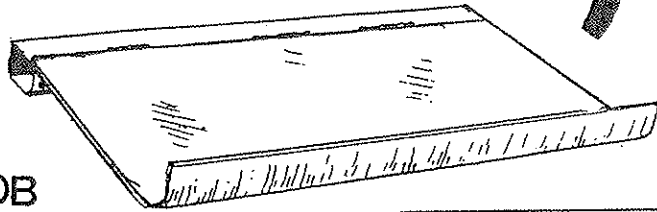

ASH DOOR KNOB

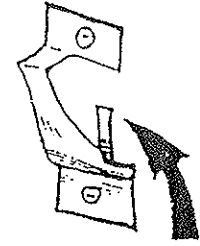

SWITCH KNOB

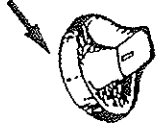

SWITCH

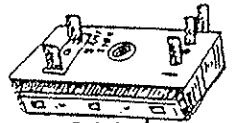

ASH DOOR

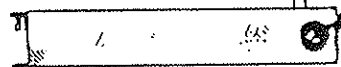

DOOR CATCH

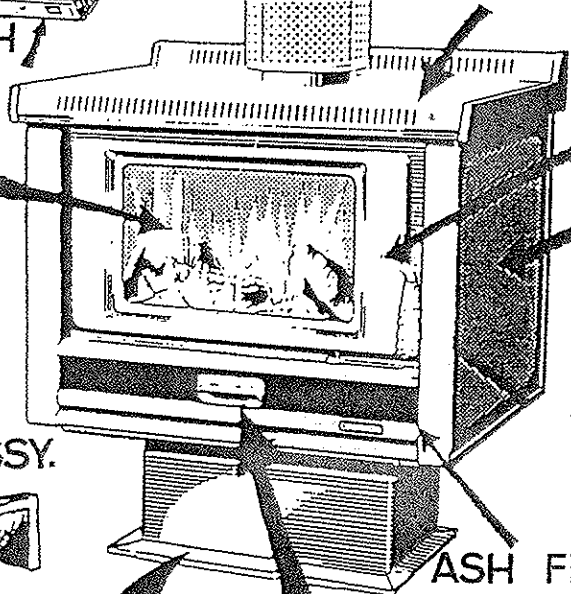

SIDE FASHION PANEL



AIRSLIDE HANDLE

SPEED CONTROL ASSY.

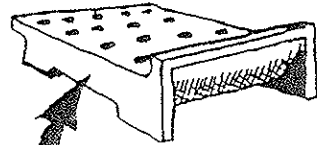
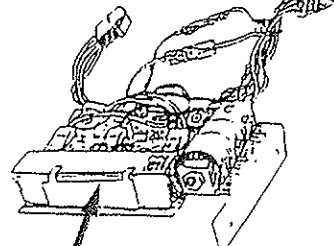

GRATE

PEDESTAL TRIM

ASH FLAP HANDLE

ASH FLAP FASHION PANEL

REAR FIREBRICK

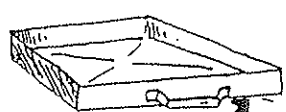

ASHPAN

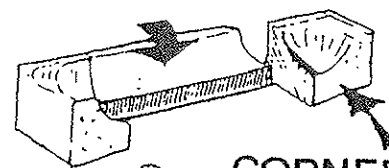

CORNER FIREBRICK

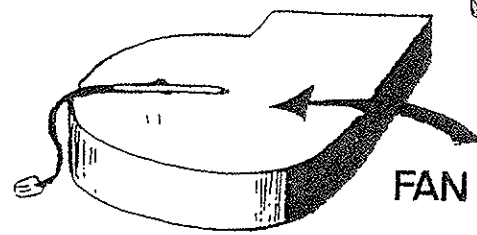

FAN ASSEMBLY

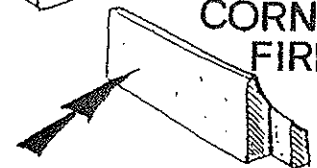

LEFT HAND FIREBRICK

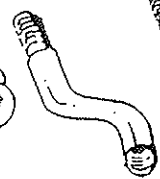
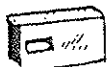

DOOR HANDLE ASSEMBLY

RIGHT HAND FIREBRICK

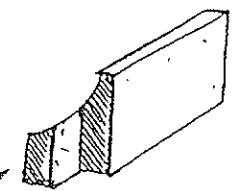

# 2100 CLASSIC FIREPLACE INSERT

## 1986 — 1994

PART NO.	DESCRIPTION
0026 .....	3 Speed Rotary Switch
1693 .....	Baffle Plate Assembly
1265/3172 .....	Grate — Pre 1988 - 3172, Post 1988 - 1265
1082/3025 .....	Fan Assembly — Pre 1990 - 1082, Post 1990 - 3025
3010 .....	Speed Control Assembly (Post 1990)
1221 .....	Corner Firebrick
1223 .....	Left Hand Firebrick
1224 .....	Right Hand Firebrick
1222 .....	Rear Firebrick
1134 .....	Door Glass
1574 .....	Door Catch
1472 .....	Wooden Airslide Handle
1518 .....	Door Handle Shaft
1522 .....	Handle Engagement Wing
0156 .....	Handle Locknut
1660 .....	Wooden Door Handle
1661 .....	Door Handle Bolt
1267 BR .....	Ash Flap Fashion Panel Brown
1267 RD .....	Ash Flap Fashion Panel Red
1267 GR .....	Ash Flap Fashion Panel Grey
1268 BR .....	Side Fashion Panel Brown
1268 RD .....	Side Fashion Panel Red
1268 GR .....	Side Fashion Panel Grey
1243 .....	Ash Pan
1467 .....	Ash Door Handle
1499 .....	Wooden Ash Flap Handle
1131 .....	Inner Door Pan
1493 .....	Complete Ash Door Assembly

**NOTE:**

Check availability of Glass Panels before ordering

**COMPLETE PARTS DIAGRAM OPPOSITE**

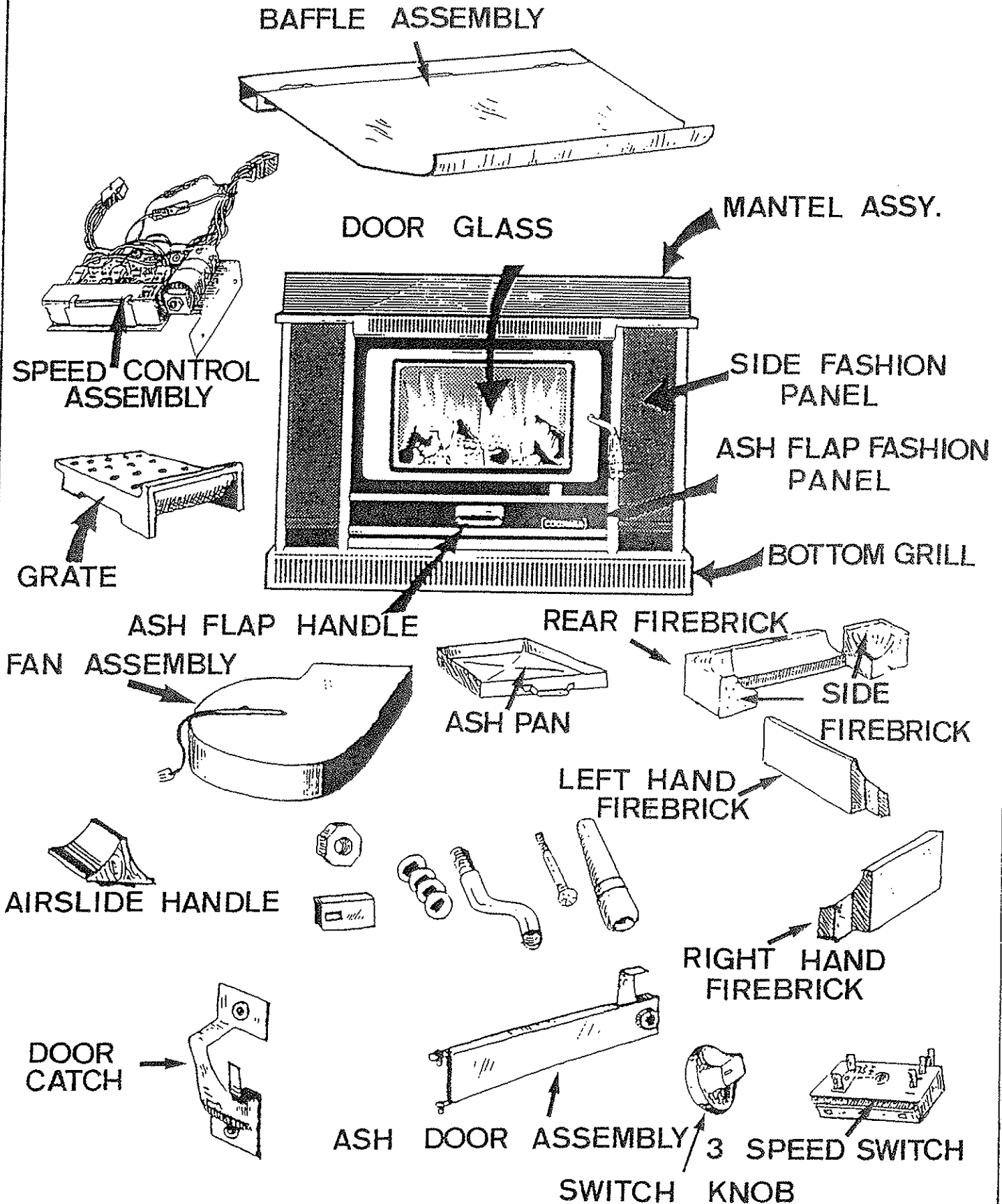



# 1900 CLASSIC FIREPLACE INSERT

## 1986 — 1995

<b>PART NO.</b>	<b>DESCRIPTION</b>
0026 .....	3 Speed Rotary Switch
1649 .....	Baffle Plate Assembly
1305/3173 .....	Grate — Pre 1988 - 3173, Post 1988 - 1305
3025/1082 .....	Fan Assembly — Pre 1990 - 1082, Post 1990 - 3025
3010 .....	Speed Control Assembly
1221 .....	Corner Firebrick
1226 .....	Left Hand Firebrick
1227 .....	Right Hand Firebrick
1225 .....	Rear Firebrick
1138 .....	Door Glass
1574 .....	Door Catch
1472 .....	Wooden Airslide Handle
1518 .....	Door Handle Shaft
1522 .....	Handle Engagement Wing
0156 .....	Handle Locknut
1660 .....	Wooden Door Handle
1661 .....	Door Handle Bolt
1307 BR .....	Ash Flap Fashion Panel Brown
1307 RD .....	Ash Flap Fashion Panel Red
1307 GR .....	Ash Flap Fashion Panel Grey
1308 BR .....	Side Fashion Panel Brown
1308 RD .....	Side Fashion Panel Red
1308 GR .....	Side Fashion Panel Grey
1285 .....	Ash Pan
1467 .....	Ash Door Handle
1499 .....	Wooden Ash Flap Handle
1136 .....	Inner Door Pan
1493 .....	Complete Ash Door Assembly

**NOTE:**

Check availability of Glass Panels before ordering

**COMPLETE PARTS DIAGRAM OPPOSITE**

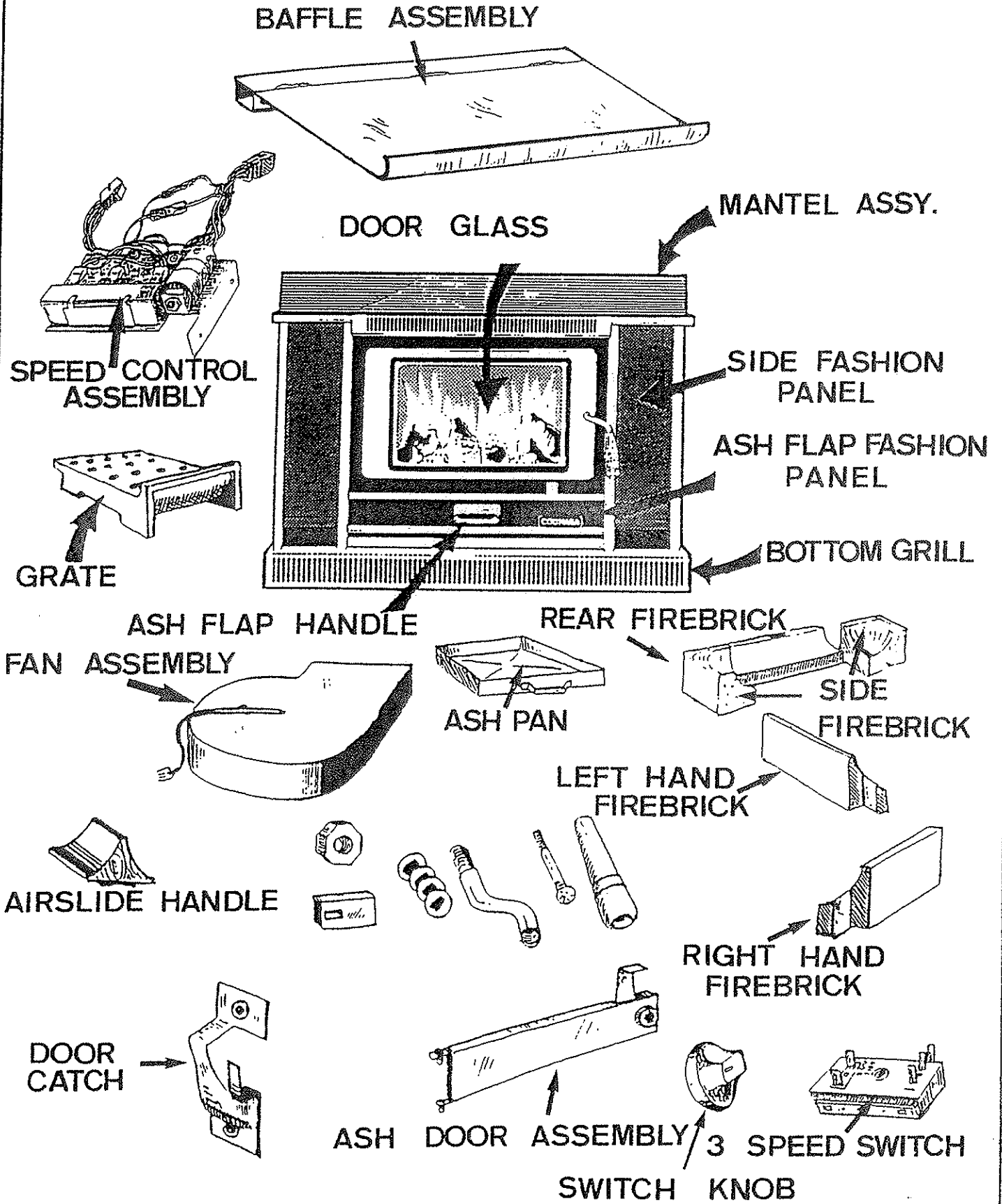

# 1200 ASHBED 1991 – 1995

<b>PART NO.</b>	<b>DESCRIPTION</b>
0026 .....	3 Speed Rotary Switch
3188 .....	Baffle Plate Assembly
3295 .....	Fire Brick (Flat Type With Chamfered Front Edge x 3)
3025 .....	Fan Assembly
3010 .....	Speed Control Assembly
3011 .....	Fan and Motor (Less Housing)
1134 .....	Door Glass
1574 .....	Door Catch
1472 .....	Wooden Airslide Handle
1518 .....	Door Handle Shaft
1522 .....	Handle Engagement Wing
0156 .....	Handle Locknut
1660 .....	Wooden Door Handle
1661 .....	Door Handle Bolt
3119 .....	Pedestal Trim
1533 BR .....	Side Fashion Panel Brown
1533 RD .....	Side Fashion Panel Red
1533 GR .....	Side Fashion Panel Grey
1131 .....	Inner Door Pan
1611 .....	Complete Switch Assembly (Including Plug and Loom)

**NOTE:**

Check availability of Glass Panels before ordering

**COMPLETE PARTS DIAGRAM OPPOSITE**

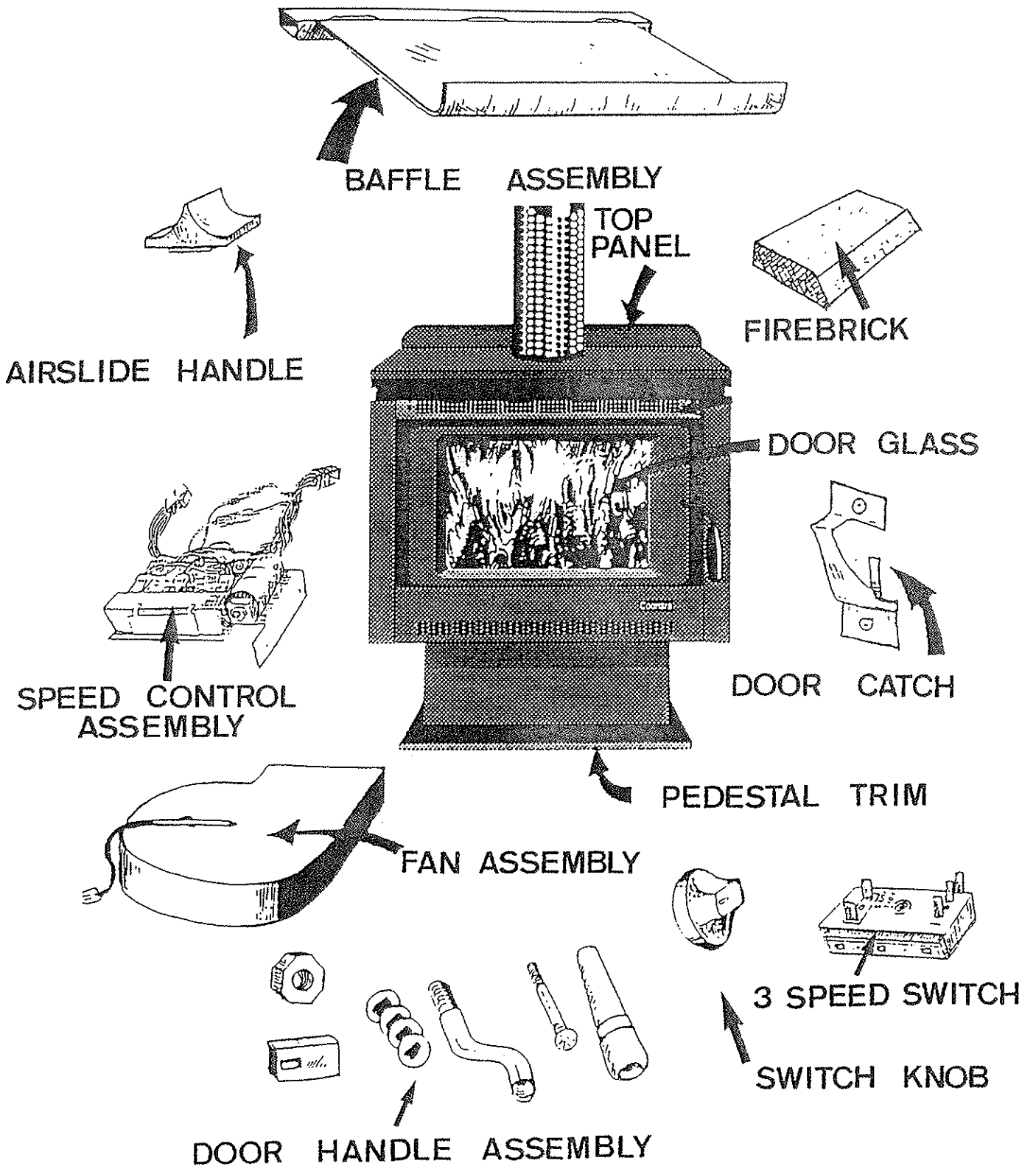

# 1000 ASHBED

## 1991 — 1994

PART NO.	DESCRIPTION
0026 .....	3 Speed Rotary Switch
3189 .....	Baffle Plate Assembly
3296/3295 .....	Fire Brick (Flat Type With Chamfered Edge x 2)
3025/2319* .....	Fan Assembly*** (See Footnote Below)
3010 .....	Speed Control Assembly
1138 .....	Door Glass
1574 .....	Door Catch
1472 .....	Wooden Airslide Handle
1518 .....	Door Handle Shaft
1522 .....	Handle Engagement Wing
0156 .....	Handle Locknut
1660 .....	Wooden Door Handle
1661 .....	Door Handle Bolt
3119 .....	Pedestal Trim
1532 BR .....	Side Fashion Panel Brown
1532 RD .....	Side Fashion Panel Red
1532 GR .....	Side Fashion Panel Grey
1136 .....	Inner Door Pan
1611 .....	Complete Switch Assembly (Including Plug and Loom)

**\*\*\*NOTE:**

All Ballarat production of 1000A's, serial numbers 70,000 and up were fitted with a new style Fan Assembly Part No. 4158.

**NOTE:**

Check availability of Glass Panels before ordering

**COMPLETE PARTS DIAGRAM OPPOSITE**

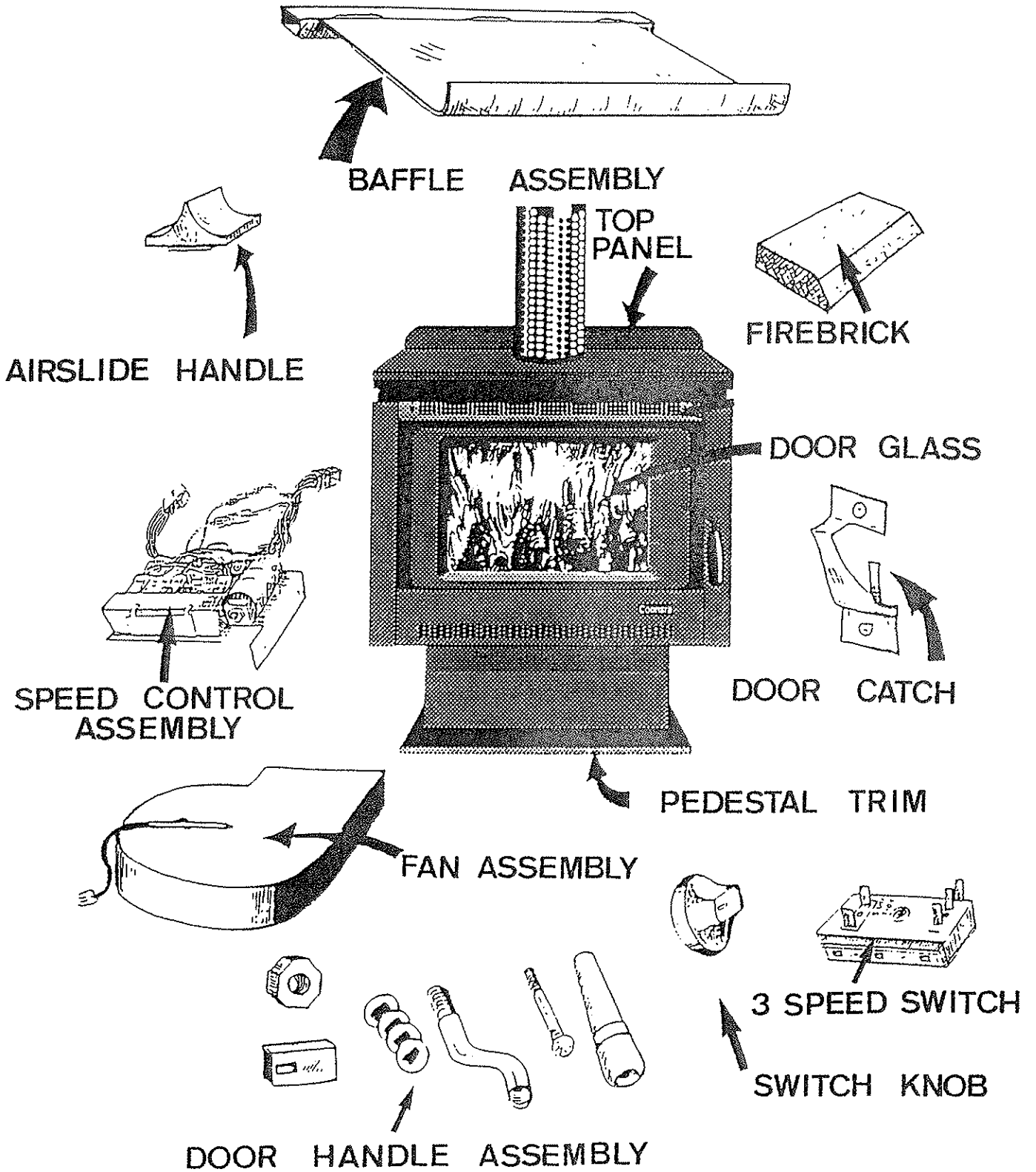

# 2100 ASHBED

## 1991 — 1994

<b>PART NO.</b>	<b>DESCRIPTION</b>
0026 .....	3 Speed Rotary Switch
3188 .....	Baffle Plate Assembly
3368 .....	Fire Brick (Flat Type With Chamfered Front Edge x 3)
3295 .....	Firebrick (Flat Type 200 mm x 100 mm x 25mm)
3025 .....	Fan Assembly
3010 .....	Speed Control Assembly
3011 .....	Fan and Motor (Less Housing)
1134 .....	Door Glass
1574 .....	Door Catch
1472 .....	Wooden Airslide Handle
1518 .....	Door Handle Shaft
1522 .....	Handle Engagement Wing
0156 .....	Handle Locknut
1660 .....	Wooden Door Handle
1661 .....	Door Handle Bolt
1268 BR .....	Side Fashion Panel Brown
1268 RD .....	Side Fashion Panel Red
1268 GR .....	Side Fashion Panel Grey
1131 .....	Inner Door Pan
1611 .....	Complete Switch Assembly (Including Plug and Loom)

**NOTE:**

Check availability of Glass Panels before ordering

**COMPLETE PARTS DIAGRAM OPPOSITE**

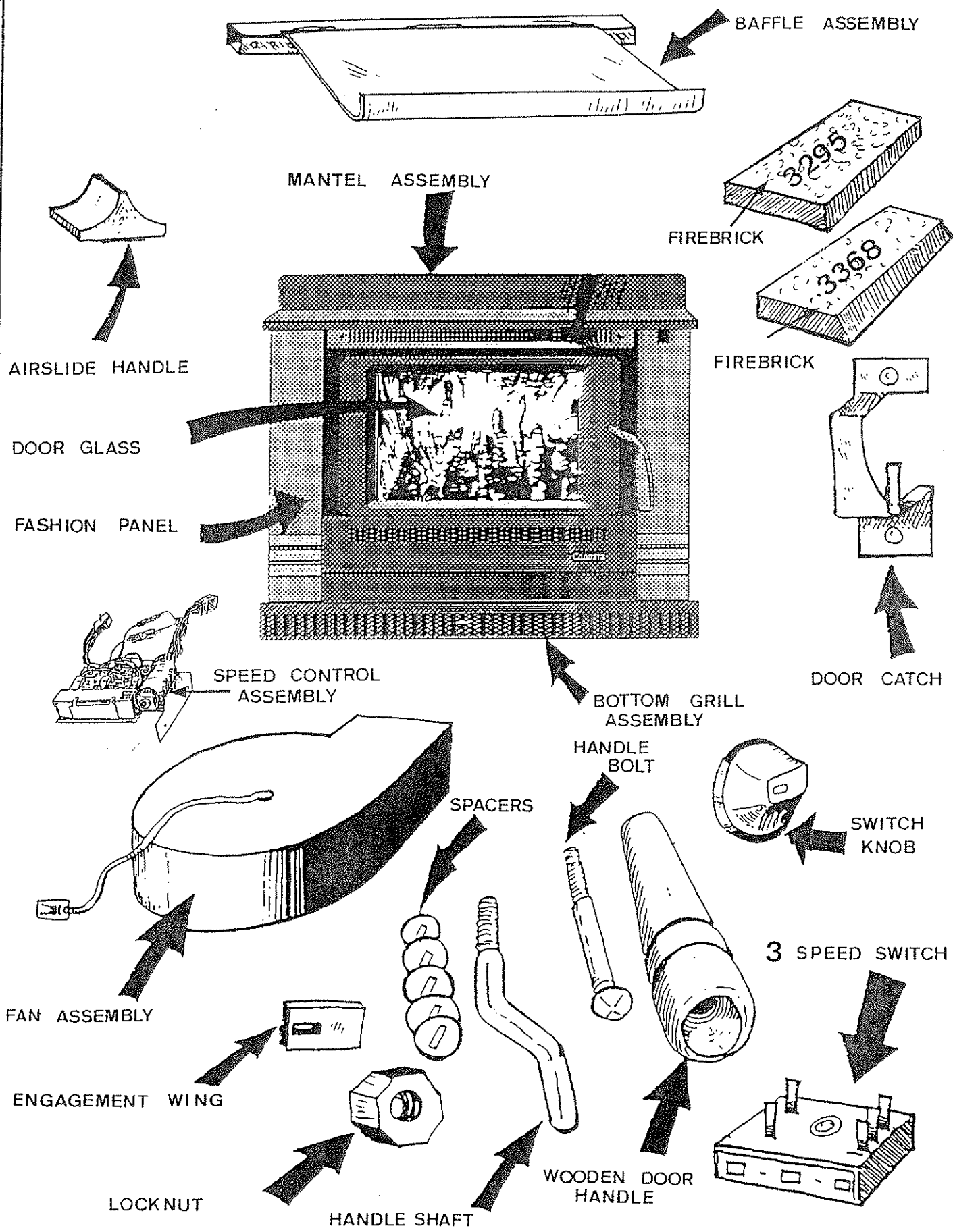



# 1900 ASHBED 1991 — 1994

<b>PART NO.</b>	<b>DESCRIPTION</b>
0026 .....	3 Speed Rotary Switch
3189 .....	Baffle Plate Assembly
3368 .....	Firebrick (Flat Type With Chamfered Front Edge x 2)
3295 .....	Firebrick (Flat Type 200 mm x 100 mm x 25mm)
3296 .....	Firebrick (Flat Type 100 mm x 100 mm x 25mm)
3369 .....	Firebrick (Flat Type with Chamfered Edge x 1 @ 100 mm x 100 mm x 25mm)
4158* .....	Fan Assembly***
1138 .....	Door Glass
1574 .....	Door Catch
1472 .....	Wooden Airslide Handle
1518 .....	Door Handle Shaft
1522 .....	Handle Engagement Wing
0156 .....	Handle Locknut
1660 .....	Wooden Door Handle
1661 .....	Door Handle Bolt
1308 BR .....	Side Fashion Panel Brown
1308 RD .....	Side Fashion Panel Red
1308 GR .....	Side Fashion Panel Grey
1136 .....	Inner Door Pan
1611 .....	Complete Switch Assembly (Including Plug and Switch)

**\*\*\*NOTE:**

All Ballarat production of 1900A's, serial numbers 70,000 and up were fitted with a new style Fan Assembly Part No. 4158.

**NOTE:**

Check availability of Glass Panels before ordering

**COMPLETE PARTS DIAGRAM OPPOSITE**

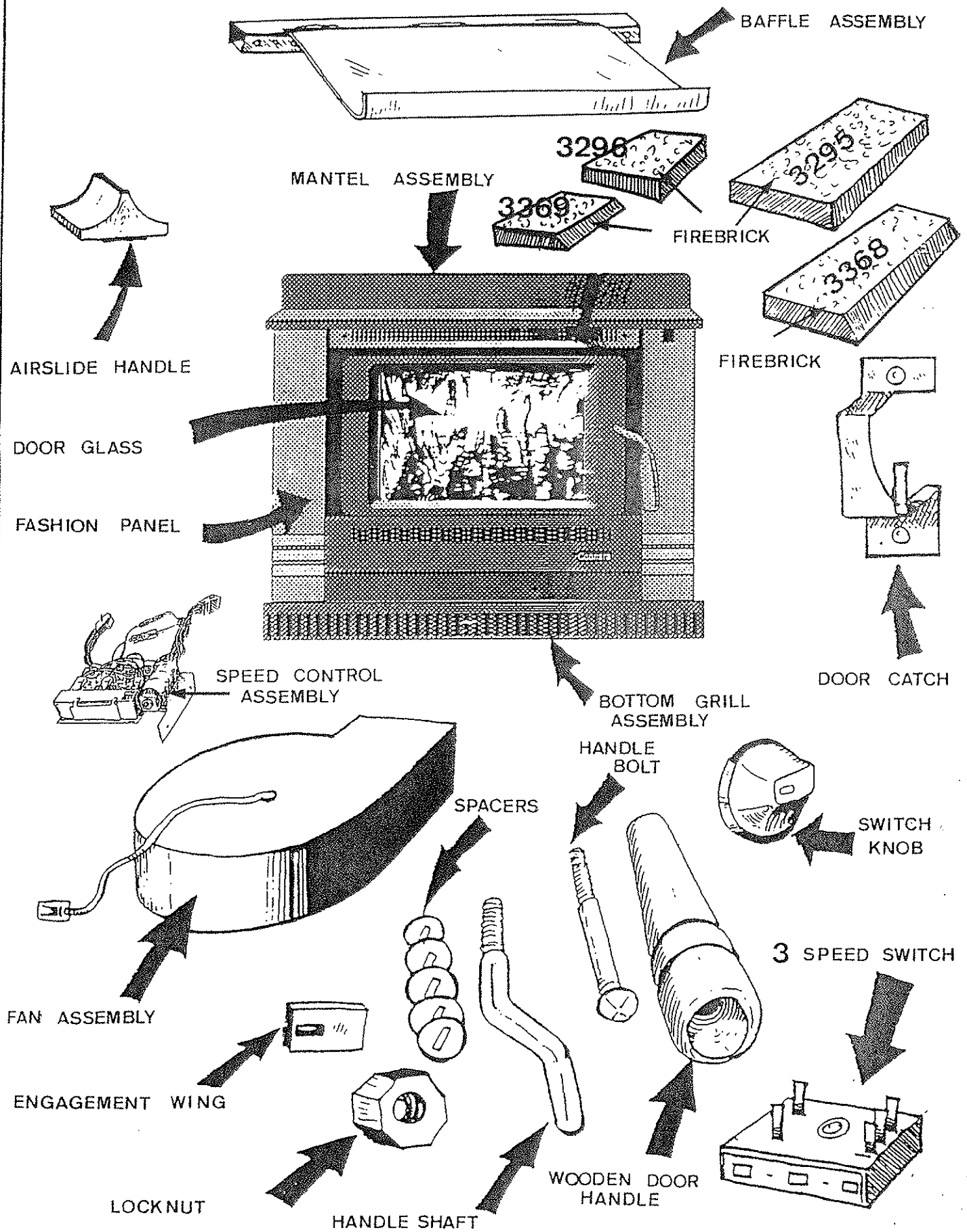

# CADET 750 1991 — 1993

<b>PART NO.</b>	<b>DESCRIPTION</b>
3219 .....	Baffle Assembly
3221 .....	Baffle Bolts & Nuts
1472 .....	Wooden Airslide Handle
1134 .....	Door Glass
1518 .....	Door Handle Shaft
1660 .....	Wooden Door Handle
1522 .....	Handle Engagement Wing
1574 .....	Door Catch
1661 .....	Door Handle Bolt
3356 .....	Pedestal Trim
1131 .....	Inner Door Pan

**COMPLETE PARTS DIAGRAM OPPOSITE**

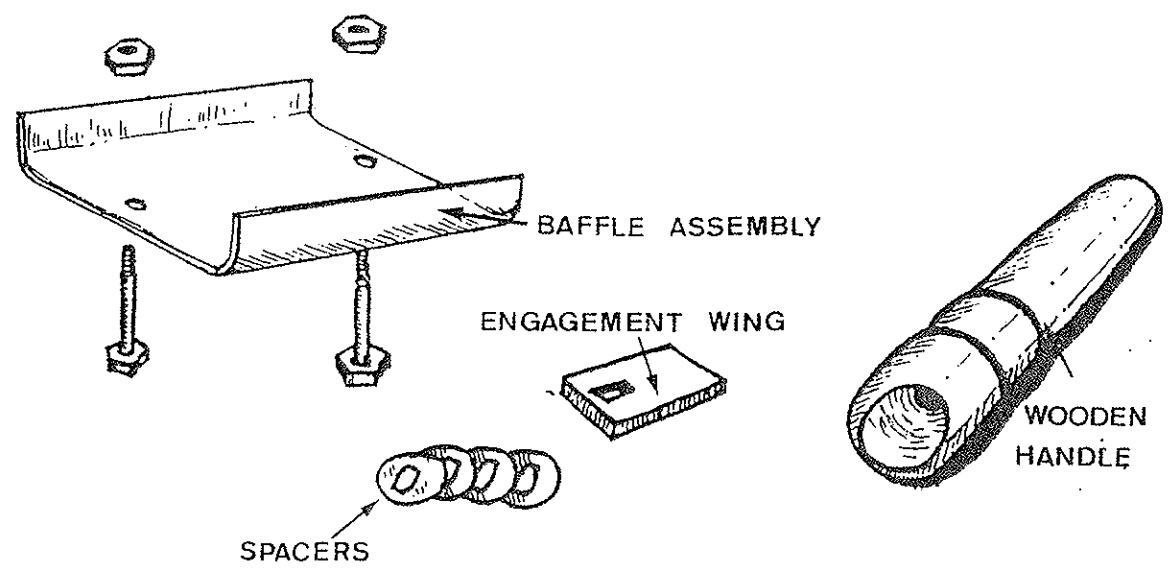
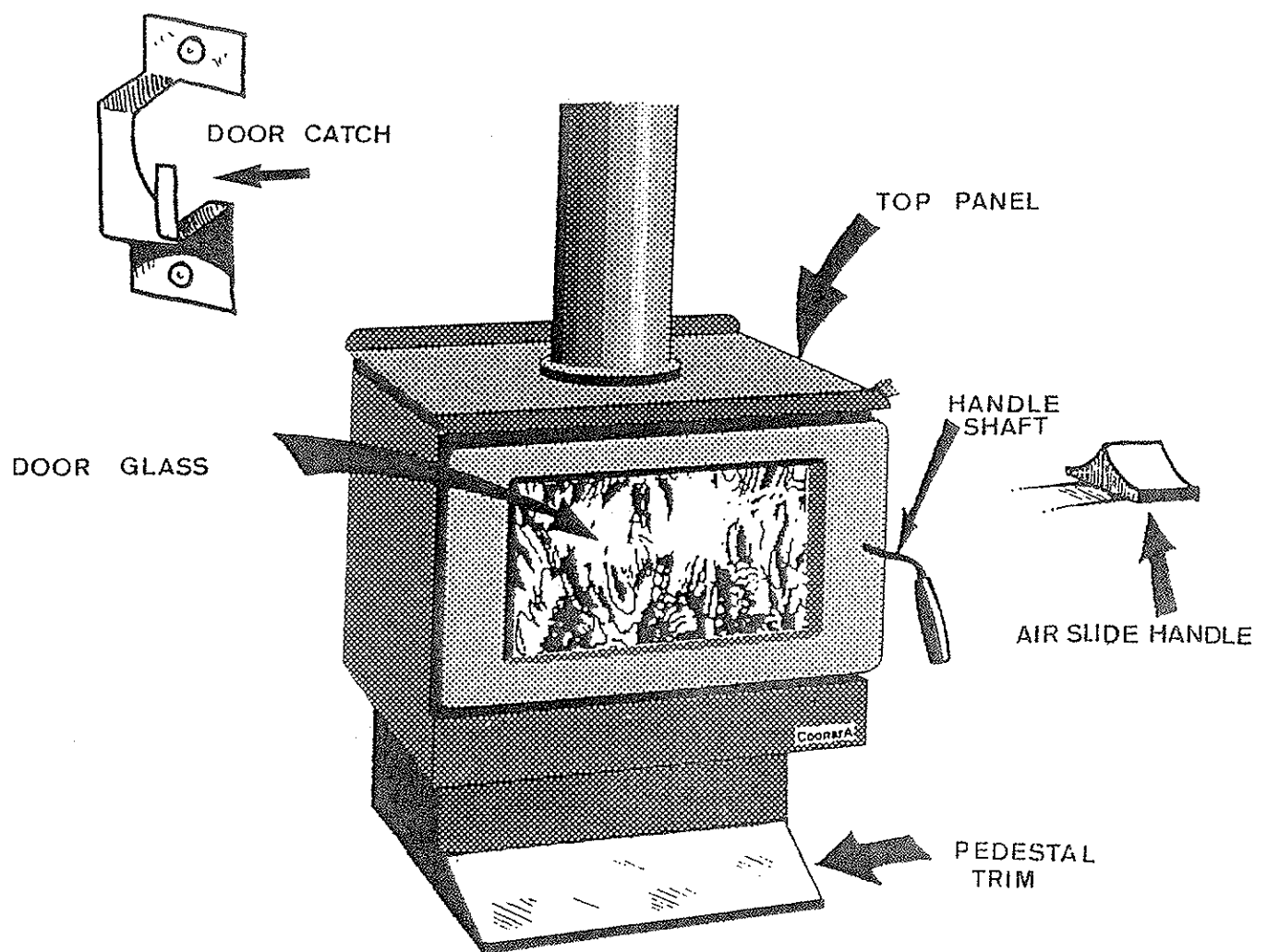

# 800 ASHBED FREESTANDER

## 1986 — 1993

PART NO.	DESCRIPTION
0026 .....	3 Speed Rotary Switch
1803 .....	Baffle Plate Assembly
1807/4158* .....	Fan Assembly*** (See Footnote Below)
1138 .....	Door Glass
1574 .....	Door Catch
1572 .....	Wooden Airslide Handle
1518 .....	Door Handle Shaft
1522 .....	Handle Engagement Wing
0156 .....	Handle Locknut
1660 .....	Wooden Door Handle
1661 .....	Door Handle Bolt
1799 BR .....	Side Fashion Panel Brown
1799 RD .....	Side Fashion Panel Red
1799 GR .....	Side Fashion Panel Grey
1136 .....	Inner Door Pan
1609 .....	Complete Door Assembly

**\*\*\*NOTE:**

All Ballarat production of 800 F/S, serial numbers 70,000 and up were fitted with a new style Fan Assembly Part No. 4158.

**NOTE:**

Check availability of Glass Panels before ordering

**COMPLETE PARTS DIAGRAM OPPOSITE**

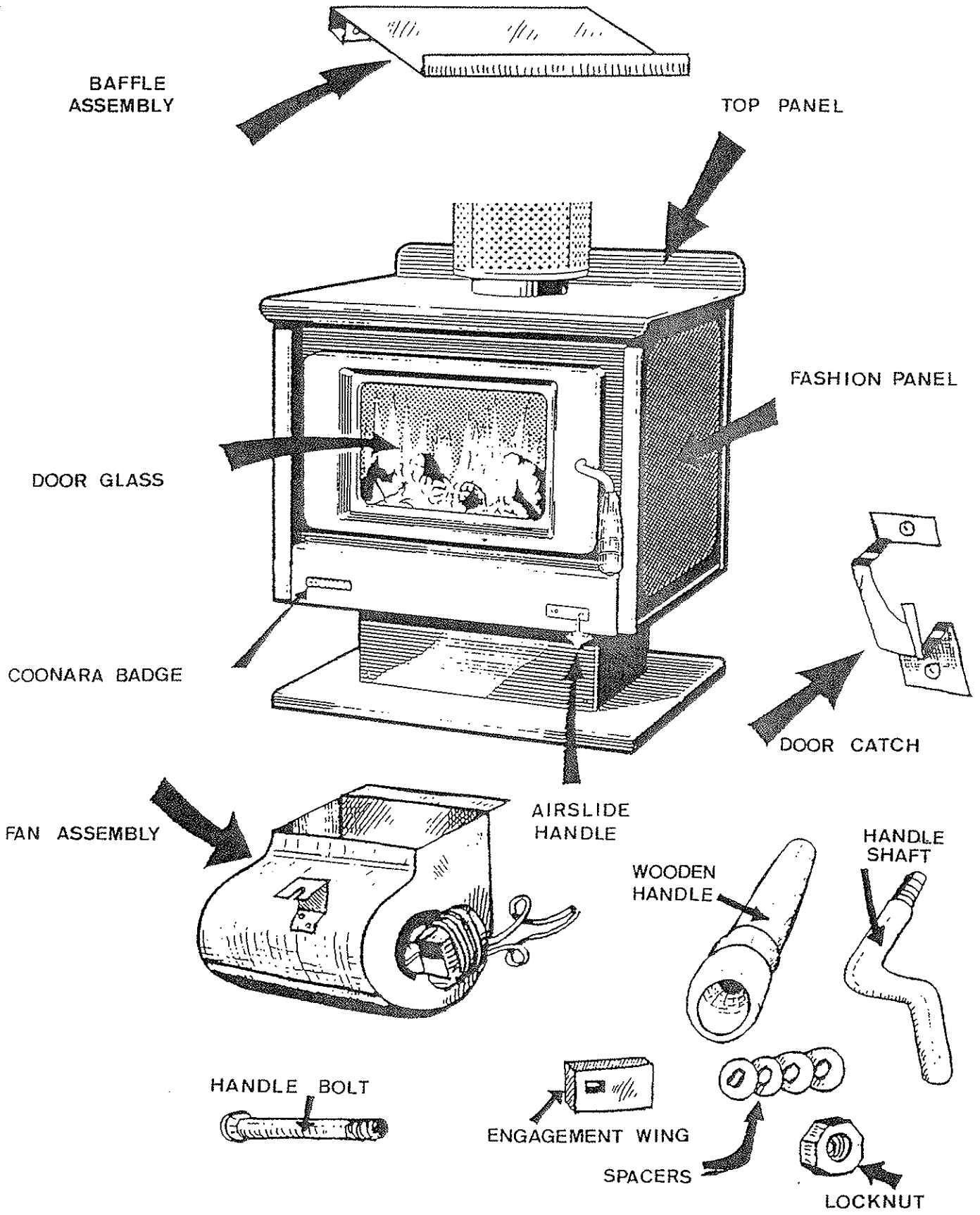

# 800 ASHBED FIREPLACE INSERT 1986 — 1993

PART NO.	DESCRIPTION
0026 .....	3 Speed Rotary Switch
1803 .....	Baffle Plate Assembly
1875/4158* .....	Fan Assembly*** (See Footnote Below)
1138 .....	Door Glass
1574 .....	Door Catch
1472 .....	Wooden Airslide Handle
1518 .....	Door Handle Shaft
1522 .....	Handle Engagement Wing
0156 .....	Handle Locknut
1660 .....	Wooden Door Handle
1661 .....	Door Handle Bolt
1848 BR .....	Side Fashion Panel Brown
1848 RD .....	Side Fashion Panel Red
1848 GR .....	Side Fashion Panel Grey
1122 .....	Coonara Badge
1136 .....	Inner Door Pan
1609 .....	Complete Door Assembly
1611 .....	Complete Switch Assembly (Including Plug and Loom)

**NOTE:**

From April 1st 1992 production, the Air Induction and Slide Control Assembly were relocated to the top right hand side of the Heater just below the Mantel. Also the Glass Fashion Panels are held by retaining angles rather than silicone, The Flue Spigot size was increased to 7mm and the Fan Assembly changed to a new high capacity Barrel Fan with a nylon wheel.

**\*\*\*NOTE:**

All Ballarat production of 800 Inserts, serial numbers 70,000 and up were fitted with a new style Fan Part No. 4158.

**NOTE:**

Check availability of Glass Panels before ordering

**COMPLETE PARTS DIAGRAM OPPOSITE**

BAFFLE ASSEMBLY



MANTEL ASSY.

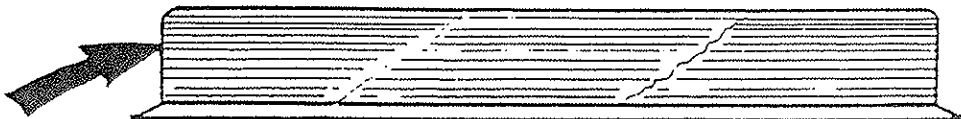

FASHION PANEL



COONARA BADGE



DOOR GLASS



AIRSLIDE HANDLE

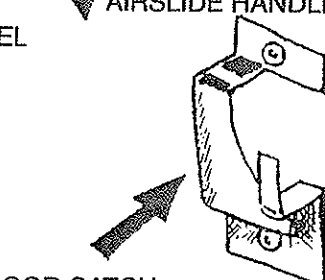

FRONT PANEL

BOTTOM GRILL ASSEMBLY



1875

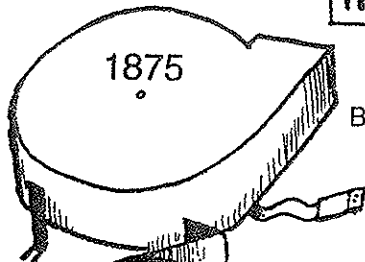

4158

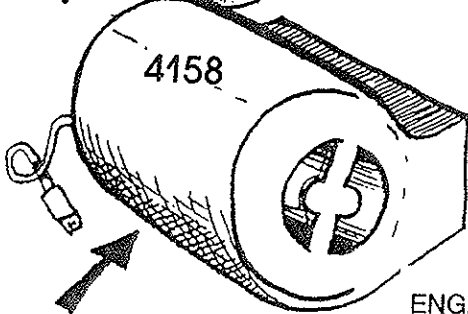

LOCK NUT



SPACERS

ENGAGEMENT WING



HANDLE



WOODEN HANDLE

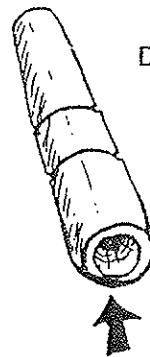

DOOR CATCH

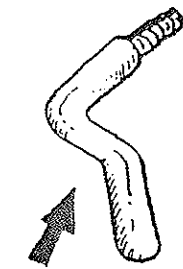

HANDLE SHAFT



# PREMIER LARGE FREESTANDER 1 1988 — 1990

PART NO.	DESCRIPTION
0026 .....	3 Speed Rotary Switch
1650 .....	Baffle Assembly
1265 .....	Grate
3035 .....	Corner Firebrick
1978 .....	L/H and R/H Firebricks
1840 .....	Rear Firebrick
1500 .....	Fan Assembly
1971 .....	Inner Door Glass
1574 .....	Door Catch
2106 .....	Wooden Airslide Handle
2096 .....	Door Handle Shaft
2097 .....	Ash Door Engagement Hook
0156 .....	Handle Locknut
1998 .....	Wooden Door Handle
1243 .....	Ashpan
2149 .....	Coonara Badge Assembly
0116 .....	Ash Flap Ball Catch
2263 .....	Mesh Door Screen

**COMPLETE PARTS DIAGRAM OPPOSITE**

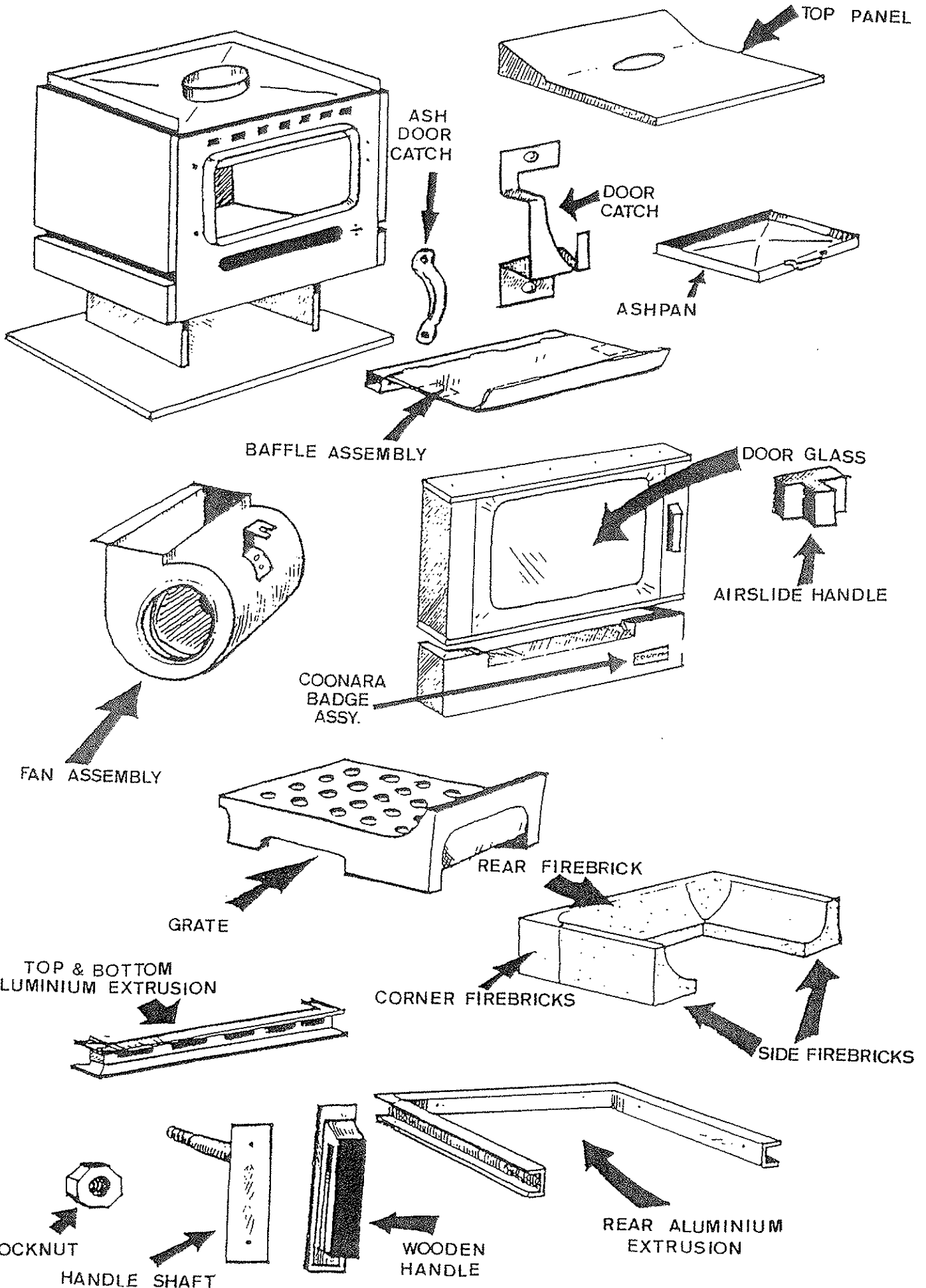

# **PREMIER MEDIUM FREESTANDER 1 1988 — 1990**

<b>PART NO.</b>	<b>DESCRIPTION</b>
0026 .....	3 Speed Rotary Switch
1649 .....	Baffle Assembly
1305 .....	Grate
3035 .....	Corner Firebrick
1977 .....	L/H and R/H Firebricks
1225 .....	Rear Firebrick
1500* .....	Fan Assembly***
1969 .....	Inner Door Glass
1574 .....	Door Catch
2106 .....	Wooden Airslide Handle
2096 .....	Door Handle Shaft
2097 .....	Ash Door Engagement Hook
0156 .....	Handle Locknut
1998 .....	Wooden Door Handle
1285 .....	Ashpan
2149 .....	Coonara Badge Assembly
0116 .....	Ash Flap Ball Catch
2262 .....	Mesh Door Screen

**COMPLETE PARTS DIAGRAM OPPOSITE**

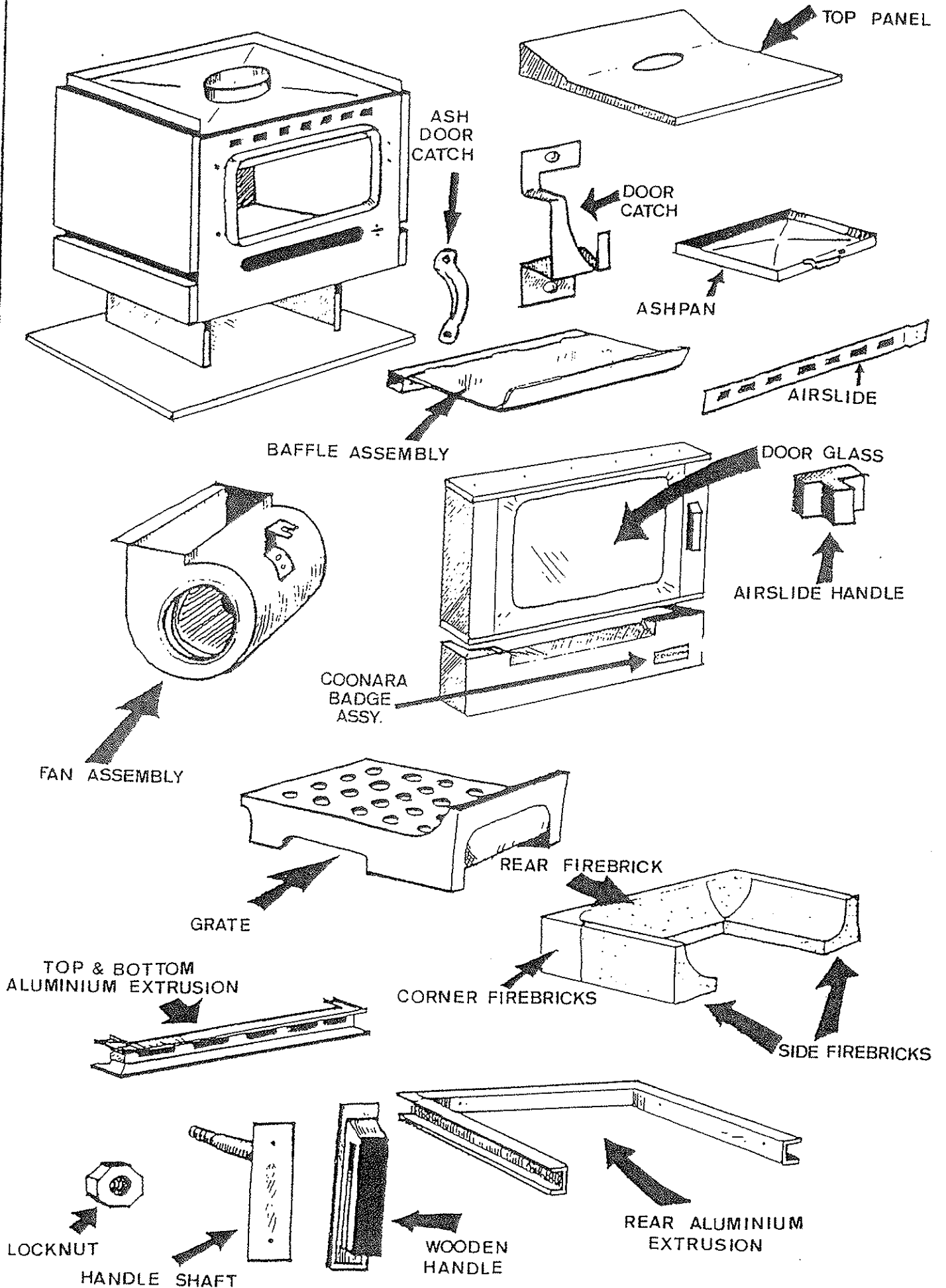

# PREMIER LARGE INSERT 1

## 1988 — 1990

PART NO.	DESCRIPTION
0026 .....	3 Speed Rotary Switch
1693 .....	Baffle Assembly
1974 .....	Grate
3035 .....	Corner Firebrick
1976 .....	L/H and R/H Firebricks
1222 .....	Rear Firebrick
1082/4012* .....	Fan Assembly*** (See Footnote Below)
1971 .....	Inner Door Glass
2105 .....	Wooden Ash Door Handle
2093 .....	Door Catch
2106 .....	Wooden Airstide Handle
2091 .....	Door Handle Shaft
2092 .....	Handle Engagement Hook
0156 .....	Handle Locknut
1998 .....	Wooden Door Handle
1243 .....	Ashpan
0113 .....	Touch Catch
0115 .....	Touch catch Keeper
2112 .....	Air Slide Badge
2149 .....	Coonara Badge Assembly
0116 .....	Ash Flap Ball Catch
2263 .....	Mesh Door Screen

**\*\*\*NOTE:**

The original Fan Assembly can be replaced with the new Fan Conversion Kit, (Part No. 4012). This new Fan has a replaceable motor and wheel assembly, and a separate Speed Control assembly.

**COMPLETE PARTS DIAGRAM OPPOSITE**

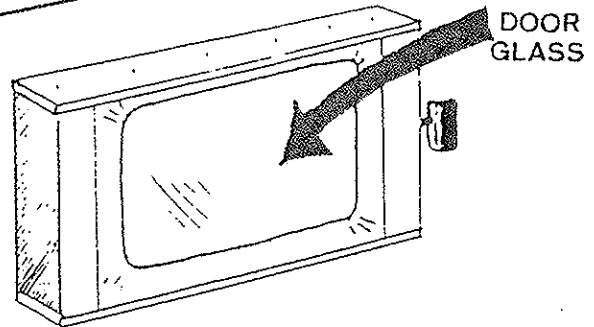
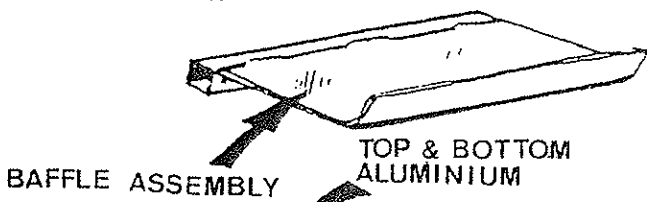
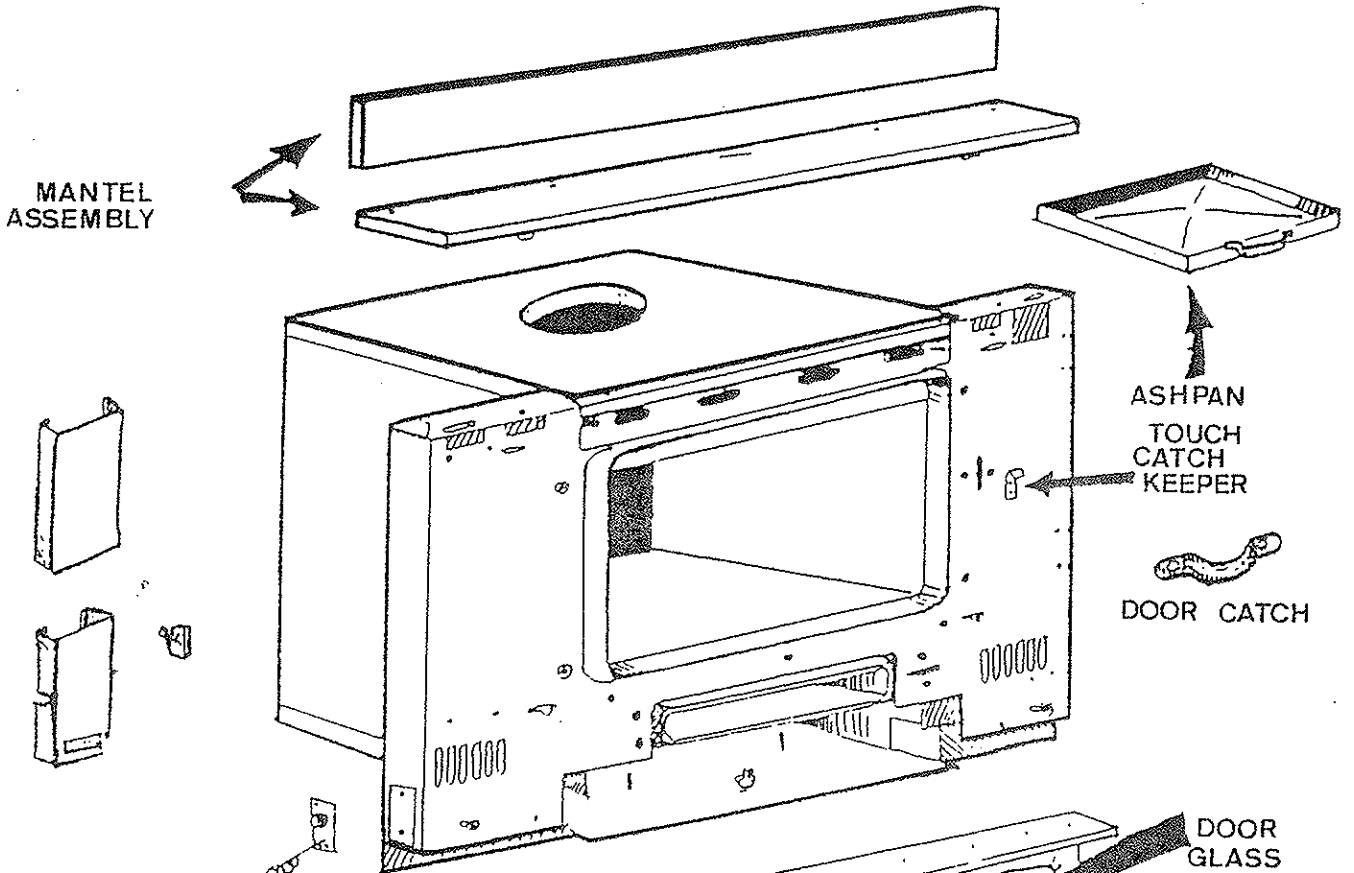
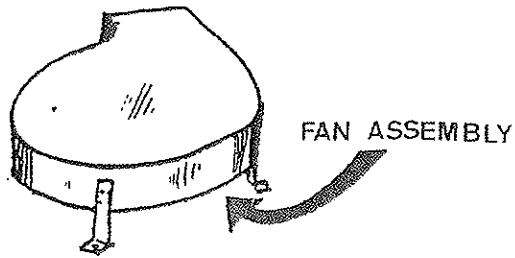

REAR FIREBRICK

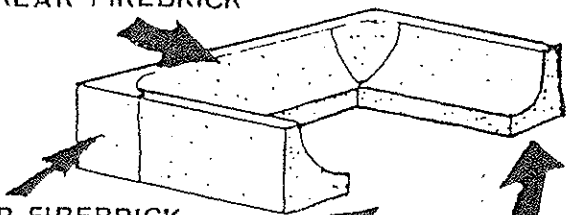

SIDE FIREBRICKS

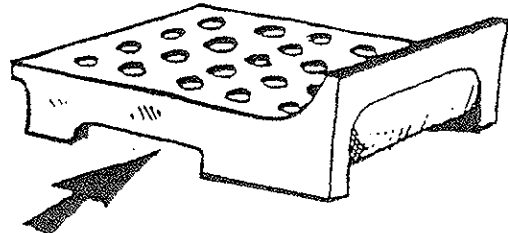

# PREMIER MEDIUM INSERT 1

## 1988 — 1990

PART NO.	DESCRIPTION
0026 .....	3 Speed Rotary Switch
1649 .....	Baffle Assembly
1973 .....	Grate
3035 .....	Corner Firebrick
1975 .....	L/H and R/H Firebricks
1225 .....	Rear Firebrick
1082/4012* .....	Fan Assembly*** (See Footnote Below)
1969 .....	Inner Door Glass
2105 .....	Wooden Ash Door Handle
2093 .....	Door Catch
2106 .....	Wooden Airslide Handle
2091 .....	Door Handle Shaft
2092 .....	Handle Engagement Hook
0156 .....	Handle Locknut
1998 .....	Wooden Door Handle
1285 .....	Ashpan
2112 .....	Air Slide Badge
2149 .....	Coonara Badge Assembly
0116 .....	Ash Flap Ball Catch
2262 .....	Mesh Door Screen

**\*\*\*NOTE:**

The original Fan Assembly can be replaced with the new Fan Conversion Kit, (Part No. 4012). This new Fan has a replaceable motor and wheel assembly, and a separate Speed Control assembly.

**COMPLETE PARTS DIAGRAM OPPOSITE**

AIR SLIDE HANDLE

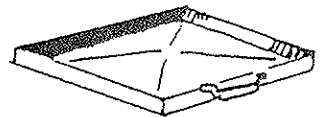
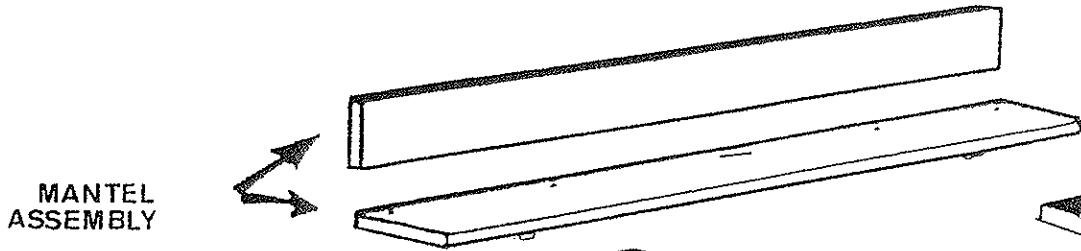
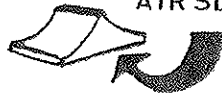
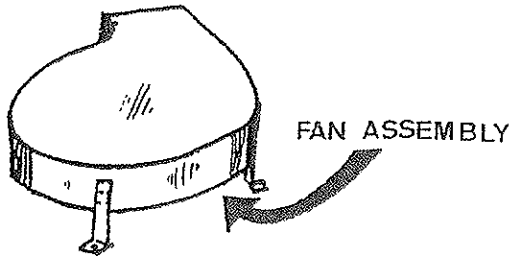

ASHPAN TOUCH CATCH KEEPER



DOOR CATCH

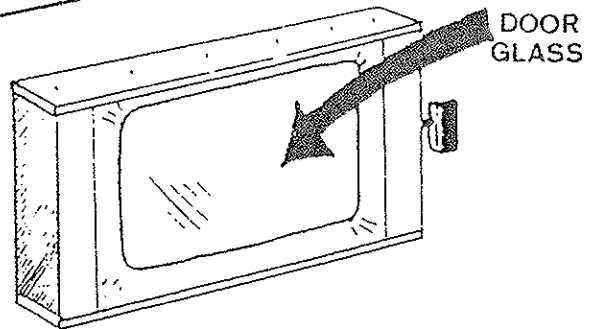
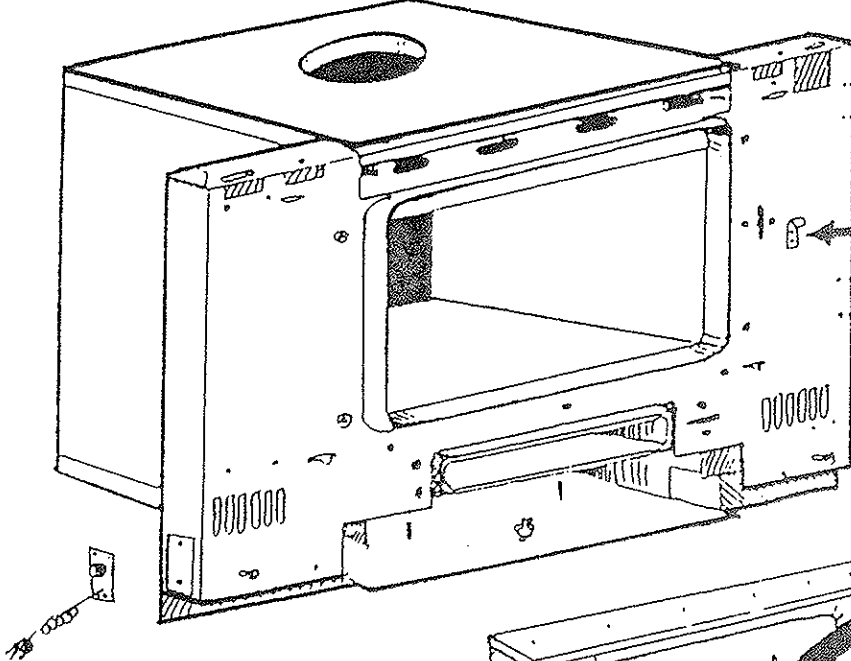

DOOR GLASS

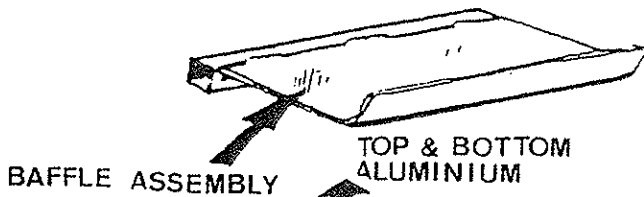

TOP & BOTTOM ALUMINIUM



REAR FIREBRICK

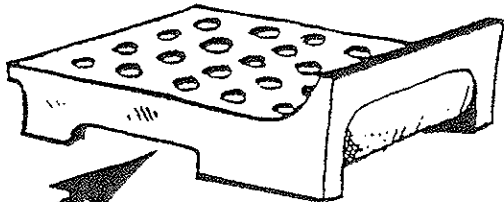

GRATE

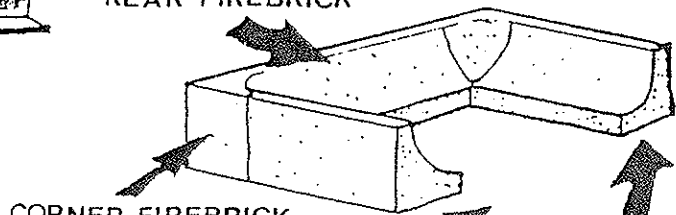

CORNER FIREBRICK

SIDE FIREBRICKS



# 1600 FREESTANDER (HIGH-TECH)

## 1986 — 1987

PART NO.	DESCRIPTION
0026 .....	3 Speed Rotary Switch
2255 .....	Rear Baffle Assembly
2257 .....	Upper Baffle Assembly
1497 .....	Secondary Air Tube Assembly
3172 .....	Grate
1221 .....	Corner Firebrick
1223 .....	Left Hand Firebrick
1224 .....	Right Hand Firebrick
1222 .....	Rear Firebrick
1134 .....	Door Glass
1500 .....	Fan Assembly
1243 .....	Ash Pan
1493 .....	Ash Door Assembly
1378 BR .....	Brown Ash Flap Fashion Panel
1378 RD .....	Red Ash Flap Fashion Panel
1660 .....	Wooden Door Handle
1015/1518* .....	Door Handle Shaft*** (See Footnote Below)
1522 .....	Handle Engagement Wing
1661 .....	Door Handle Bolt
0156 .....	Handle Locknut
1499 .....	Wooden Ash Flap Handle
1574 .....	Door Catch
1472 .....	Air Slide Wooden Handle
1131 .....	Inner Door Pan
1465 .....	Ash Door Engagement Wing

**\*\*\*NOTE:**

The very first Series 2 Hi-Tech Heaters used a threaded Handle Shaft with an Engagement Wing and Door Catch like the Series 1 Heaters. This was only used for a short time before a revised Handle and Catch was made, (non threaded type Handle). See Drawing.

**NOTE:**

Check availability of Glass Panels before ordering

**COMPLETE PARTS DIAGRAM OPPOSITE**

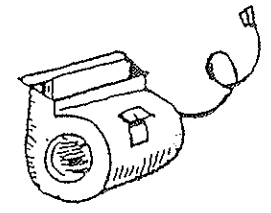
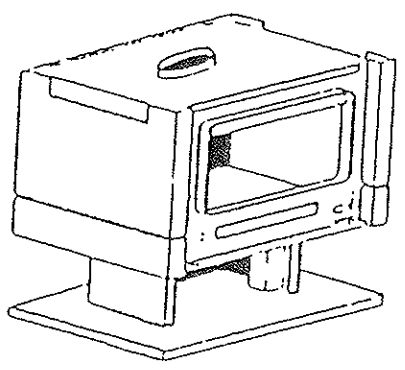
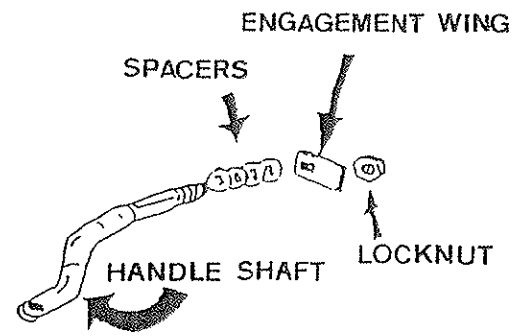

FAN ASSEMBLY



SECONDARY AIR TUBE

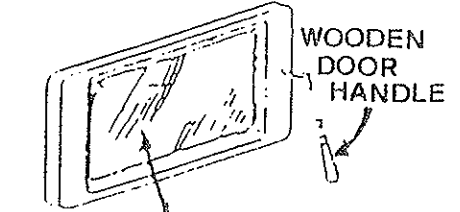
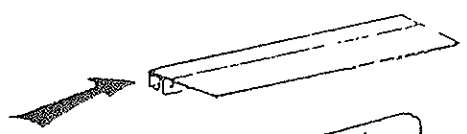

DOOR GLASS

REAR BAFFLE ASSY.

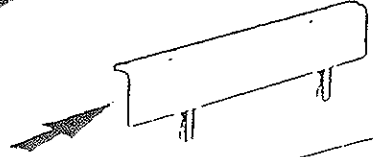

UPPER BAFFLE ASSEMBLY

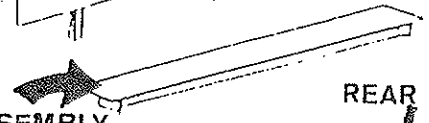

REAR FIREBRICKS

R.H. FIREBRICK

L.H. FIREBRICK

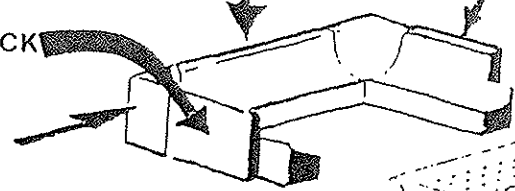

CORNER FIREBRICK



GRATE

ASH PAN



ASH DOOR HANDLE

ASH DOOR



ASH FLAP



FASHION PANEL

WOODEN ASH FLAP HANDLE

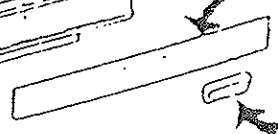

# 1400 FREESTANDER (HIGH-TECH) 1986 — 1987

PART NO.	DESCRIPTION
0026 .....	3 Speed Rotary Switch
2256 .....	Rear Baffle Assembly
2258 .....	Upper Baffle Assembly
1498 .....	Secondary Air Tube Assembly
3173 .....	Grate
1221 .....	Corner Firebrick
1226 .....	Left Hand Firebrick
1227 .....	Right Hand Firebrick
1225 .....	Rear Firebrick
1138 .....	Door Glass
1500 .....	Fan Assembly
1285 .....	Ash Pan
1494 .....	Ash Door Assembly
1377 BR .....	Brown Ash Flap Fashion Panel
1377 RD .....	Red Ash Flap Fashion Panel
1660 .....	Wooden Door Handle
1015/1518* .....	Door Handle Shaft*** (See Footnote Below)
1522 .....	Handle Engagement Wing
1661 .....	Door Handle Bolt
0156 .....	Handle Locknut
1499 .....	Wooden Ash Flap Handle
1574 .....	Door Catch
1472 .....	Air Slide Wooden Handle
1136 .....	Inner Door Pan
1465 .....	Ash Door Engagement Wing

**\*\*\*NOTE:**

The very first Series 2 Hi-Tech Heaters used a threaded Handle Shaft with an Engagement Wing and Door Catch like the Series 1 Heaters. This was only used for a short time before a revised Handle and Catch was made, (non threaded type Handle). See Drawing.

**NOTE:**

Check availability of Glass Panels before ordering

**COMPLETE PARTS DIAGRAM OPPOSITE**

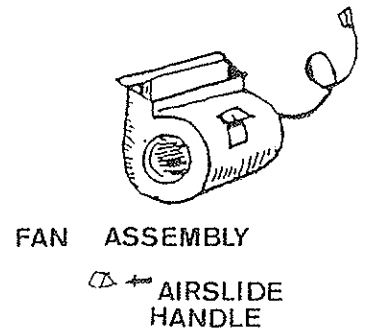
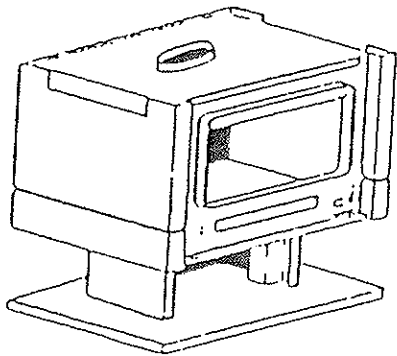
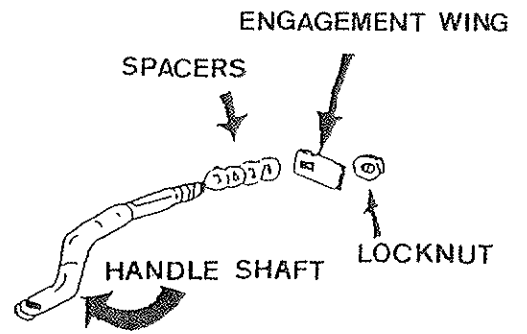

SECONDARY AIR TUBE

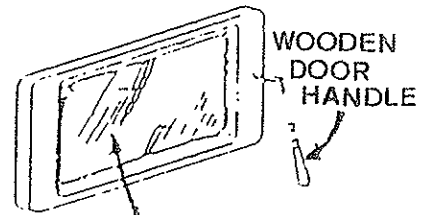

DOOR GLASS

REAR BAFFLE ASSY.

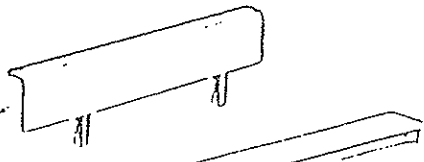

UPPER BAFFLE ASSEMBLY

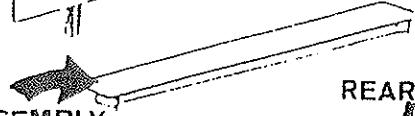

REAR FIREBRICKS R.H. FIREBRICK

L.H. FIREBRICK

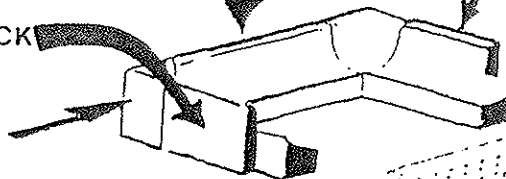

CORNER FIREBRICK



GRATE

ASH DOOR HANDLE



ASH PAN

ASH DOOR



ASH FLAP



FASHION PANEL

WOODEN ASH FLAP HANDLE



# 2200 FIREPLACE INSERT (HIGH-TECH)

## 1986 — 1987

PART NO.	DESCRIPTION
0026 .....	3 Speed Rotary Switch
2255 .....	Rear Baffle Assembly
2257 .....	Upper Baffle Assembly
1497 .....	Secondary Air Tube Assembly
3172 .....	Grate
1221 .....	Corner Firebrick
1223 .....	Left Hand Firebrick
1224 .....	Right Hand Firebrick
1222 .....	Rear Firebrick
1134 .....	Door Glass
1082/4012* .....	Fan Assembly** (See Footnote Below)
1243 .....	Ash Pan
1493 .....	Ash Door Assembly
1267 BR .....	Brown Ash Flap Fashion Panel
1267 RD .....	Red Ash Flap Fashion Panel
1268 BR .....	Brown Front Panel
1268 RD .....	Red Front Panel
1660 .....	Wooden Door Handle
1015/1518* .....	Door Handle Shaft*** (See Footnote Below)
1522 .....	Handle Engagement Wing
1661 .....	Door Handle Bolt
0156 .....	Handle Locknut
1499 .....	Wooden Ash Flap Handle
1574 .....	Door Catch
1472 .....	Air Slide Wooden Handle
1131 .....	Inner Door Pan
1465 .....	Ash Door Engagement Wing

**\*\*NOTE:**

Part No. 4012 consists of Part No. 3025-Fan Assembly and Part No. 3010-Speed Control.

**\*\*\*NOTE:**

The very first Series 2 Hi-Tech Heaters used a threaded Handle Shaft with an Engagement Wing and Door Catch like the Series 1 Heaters. This was only used for a short time before a revised Handle and Catch was made, (non threaded type Handle). See Drawing.

**NOTE:**

Check availability of Glass Panels before ordering

**COMPLETE PARTS DIAGRAM OPPOSITE**

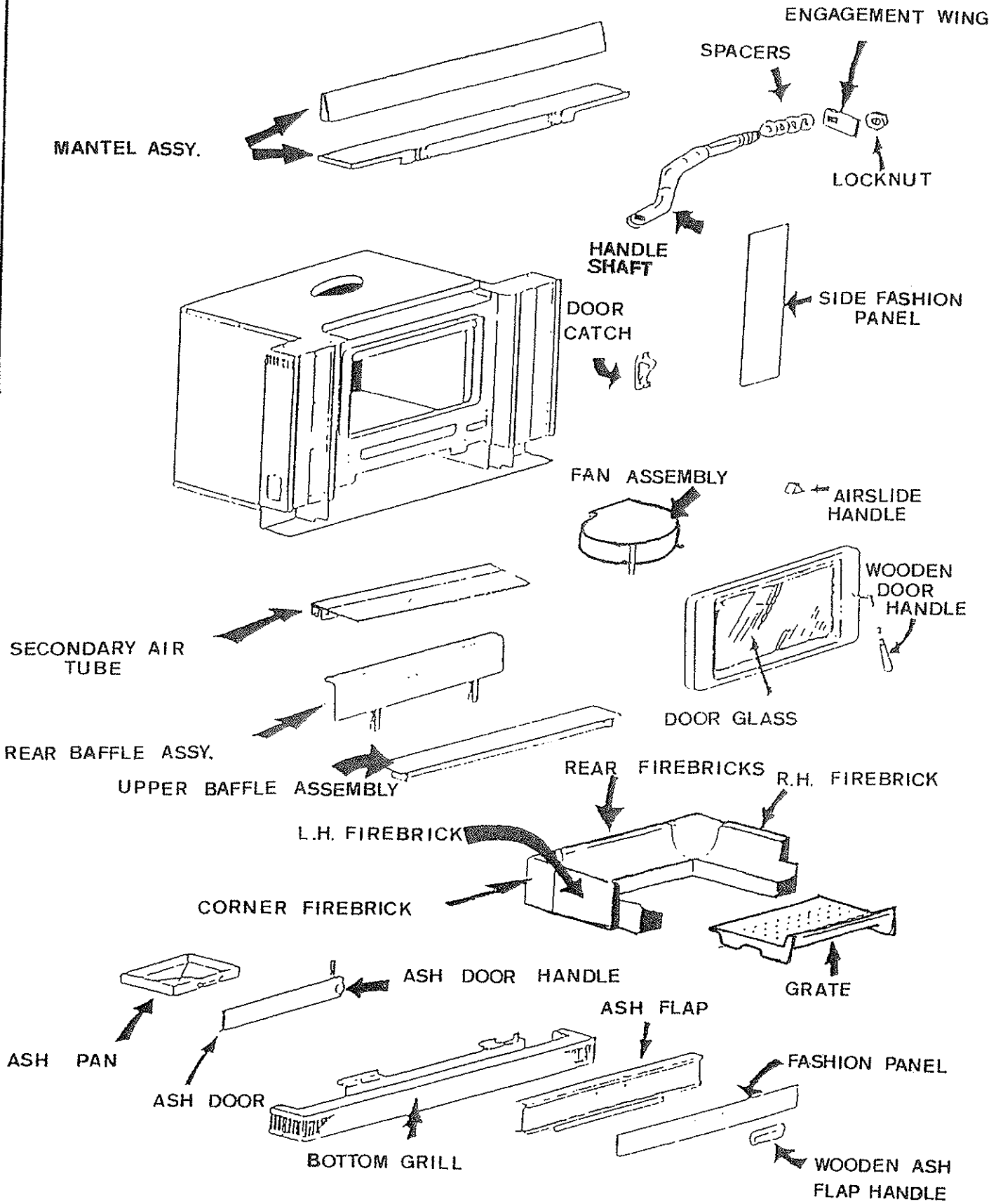

# 2000 FIREPLACE INSERT (HIGH-TECH) 1986 — 1987

PART NO.	DESCRIPTION
0026 .....	3 Speed Rotary Switch
2256 .....	Rear Baffle Assembly
2258 .....	Upper Baffle Assembly
1498 .....	Secondary Air Tube Assembly
3173 .....	Grate
1221 .....	Corner Firebrick
1226 .....	Left Hand Firebrick
1227 .....	Right Hand Firebrick
1225 .....	Rear Firebrick
1138 .....	Door Glass
1082/4012* .....	Fan Assembly** (See Footnote Below)
1285 .....	Ash Pan
1494 .....	Ash Door Assembly
1307 BR .....	Brown Ash Flap Fashion Panel
1307 RD .....	Red Ash Flap Fashion Panel
1308 BR .....	Brown Front Panel
1308 RD .....	Red Front Panel
1660 .....	Wooden Door Handle
1015/1518* .....	Door Handle Shaft*** (See Footnote Below)
1522 .....	Handle Engagement Wing
1661 .....	Door Handle Bolt
0156 .....	Handle Locknut
1499 .....	Wooden Ash Flap Handle
1574 .....	Door Catch
1472 .....	Air Slide Wooden Handle
1136 .....	Inner Door Pan
1465 .....	Ash Door Engagement Wing

**\*\*NOTE:**

Part No. 4012 consists of Part No. 3025-Fan Assembly and Part No. 3010-Speed Control.

**\*\*\*NOTE:**

The very first Series 2 Hi-Tech Heaters used a threaded Handle Shaft with an Engagement Wing and Door Catch like the Series 1 Heaters. This was only used for a short time before a revised Handle and Catch was made, (non threaded type Handle). See Drawing.

**NOTE:**

Check availability of Glass Panels before ordering

**COMPLETE PARTS DIAGRAM OPPOSITE**

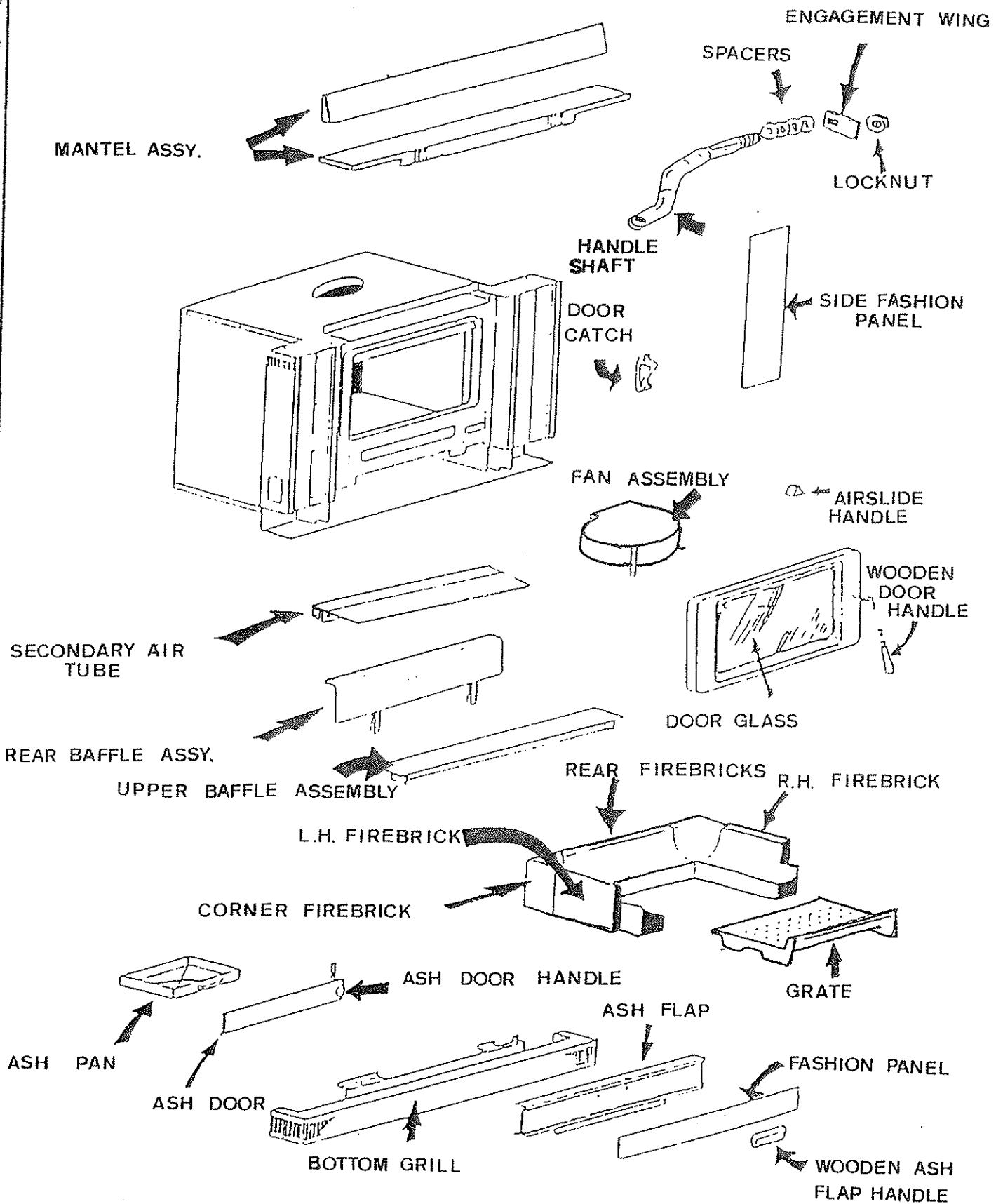



# 2400 SERIES 1 FREESTANDER

## 1982 — Late 1985

PART NO.	DESCRIPTION
0026 .....	3 Speed Rotary Switch
1027 .....	Baffle Plate
1026* .....	Baffle Plate Hangers* (See Footnote Below)
1050 .....	Left Hand Grate
1051 .....	Right Hand Grate
1057 .....	Left and Right Hand Grates (Set)
1052 .....	Left Hand Liner
1053 .....	Right Hand Liner
1054 .....	Rear Liner
1063** .....	Fan Assembly** (See Footnote Below)
*** .....	Door Glass*** (See Footnote Below)
1013 .....	Handle Engagement Wing
1015 .....	Threaded Handle Shaft
1660 .....	Wooden Handle
1661 .....	Door Handle Bolt
1056 .....	Wooden (Coonara) Ash Flap Handle
1190 .....	Ash Door Handle

**NOTE:**

Some parts for this Heater are not available - i.e. Double Handle versions - Handle, Shaft & Engagement Wing.

**\*NOTE:**

Baffle Hangers must be welded in place.

**\*\*NOTE:**

Some early Fans were operated by a variable speed switch which is no longer available. After market variable switches are available such as Arlec or HPM.

**\*\*\*NOTE:**

Several different configurations of Door Assemblies were available over the years so please check the Glass size before ordering. Refer page 8.

**COMPLETE PARTS DIAGRAM OPPOSITE**

Engagement Wing



Handle Shaft

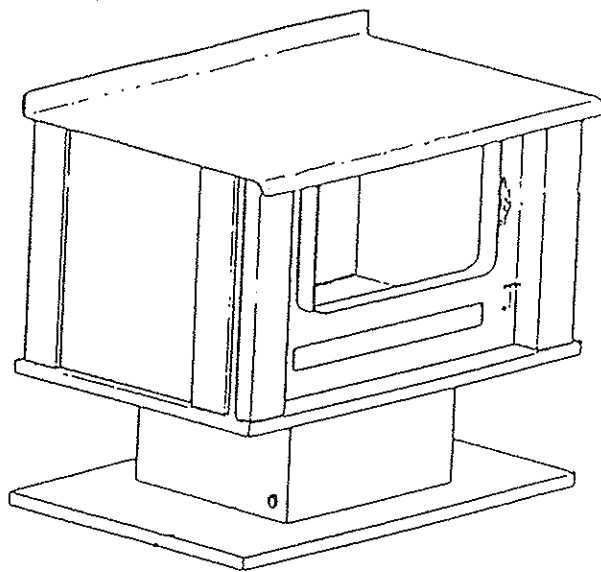

Ash door Knob

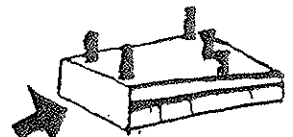

3 Speed switch

Fan Assembly

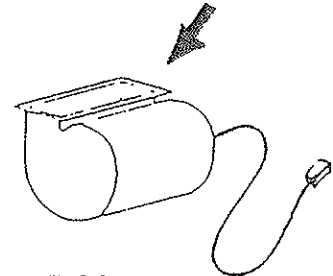

Baffle plate

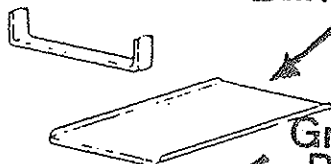

Baffle hangers



Grate R.H.

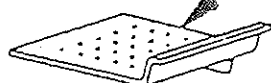

Grate L.H.

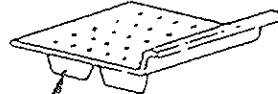

R-H Liner

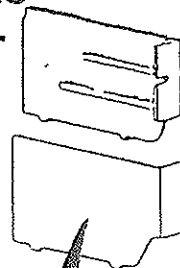

L.H. Liner

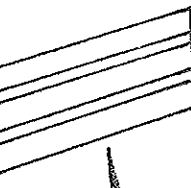

Rear Liner

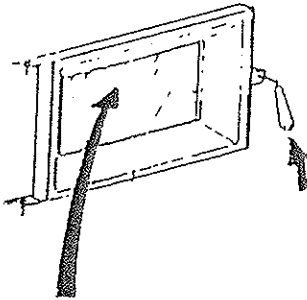

Door glass



Ashpan



Ash door

Wooden ash flap handle



Ash flap

# 1800 SERIES 1 FREESTANDER 1982 — Late 1985

<b>PART NO.</b>	<b>DESCRIPTION</b>
0026 .....	3 Speed Rotary Switch
1143 .....	Baffle Plate
1142* .....	Baffle Plate Hangers* (See Footnote Below)
1153 .....	Left Hand Grate
1152 .....	Right Hand Grate
1157 .....	Left and Right Hand Grates (Set)
1155 .....	Left Hand Liner
1154 .....	Right Hand Liner
1156 .....	Rear Liner
1063** .....	Fan Assembly** (See Footnote Below)
*** .....	Door Glass*** (See Footnote Below)
1013 .....	Handle Engagement Wing
1015 .....	Threaded Handle Shaft
1660 .....	Wooden Handle
1661 .....	Door Handle Bolt
1056 .....	Wooden (Coonara) Ash Flap Handle
1190 .....	Ash Door Handle

**NOTE:**

Some parts for this Heater are not available - i.e. Double Handle versions - Handle, Shaft & Engagement Wing.

**\*NOTE:**

Baffle Hangers must be welded in place.

**\*\*NOTE:**

Some early Fans were operated by a variable speed switch which is no longer available. After market variable switches are available such as Arlec or HPM.

**\*\*\*NOTE:**

Several different configurations of Door Assemblies were available over the years so please check the Glass size before ordering. Refer page 8.

**COMPLETE PARTS DIAGRAM OPPOSITE**

Engagement Wing

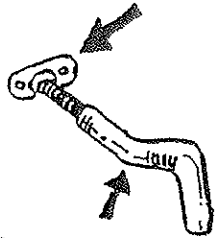

Handle Shaft

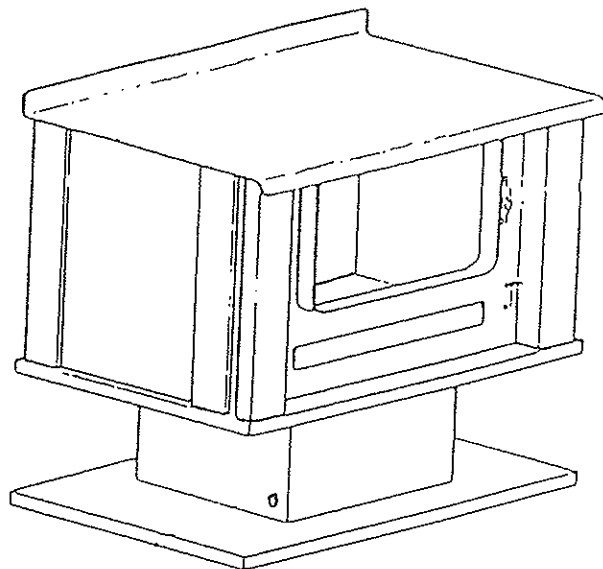

Ash door Knob

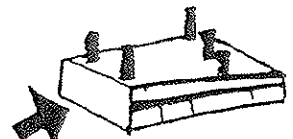

3 Speed switch

Fan Assembly

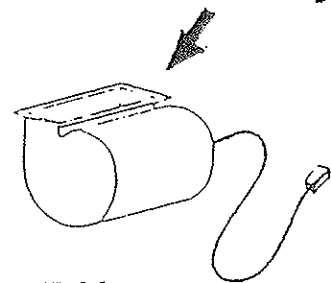

Baffle plate

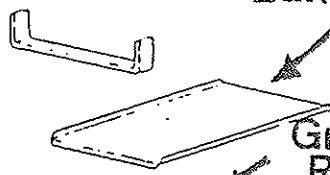

Baffle hangers

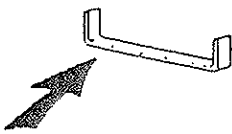

Grate R.H.

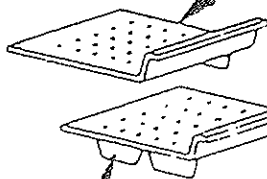

R-H Liner

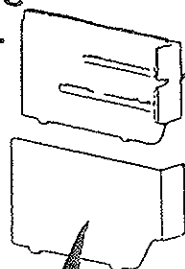

Grate L.H.

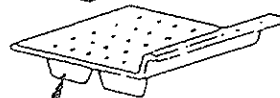

L.H. Liner



Rear Liner

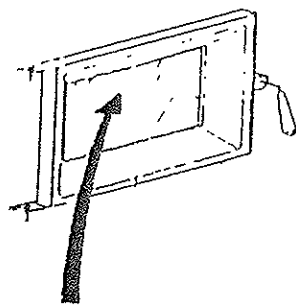
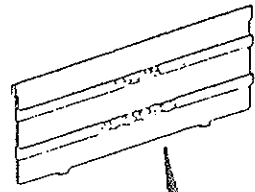

Door glass



Ashpan



Ash door

Wooden ash flap handle



Ash flap

# 2200 SERIES 1 FIREPLACE INSERT 1982 — Late 1985

PART NO.	DESCRIPTION
0026 .....	3 Speed Rotary Switch
0025 .....	2 Speed Switch
1027 .....	Baffle Plate
1026* .....	Baffle Plate Hangers* (See Footnote Below)
1050 .....	Left Hand Grate
1051 .....	Right Hand Grate
1057 .....	Left and Right Hand Grates (Set)
1052 .....	Left Hand Liner
1053 .....	Right Hand Liner
1054 .....	Rear Liner
1082/1930/3 .....	Fan Assembly** (See Footnote Below)
*** .....	Door Glass*** (See Footnote Below)
1013 .....	Handle Engagement Wing
1015 .....	Threaded Handle Shaft
1660 .....	Wooden Handle
1661 .....	Door Handle Bolt
1056 .....	Wooden (Coonara) Ash Flap Handle
1190 .....	Ash Door Handle

**NOTE:**

Some parts for this Heater are not available, i.e. Double Handle versions - Handle, Shaft & Engagement Wing.

**\*NOTE:**

Baffle Hangers must be welded in place.

**\*\*NOTE:**

Some early Fans were operated by a variable speed switch which is no longer available. After market variable switches are available such as Arlec or HPM. The Fan Assembly for this model up until 1985 was the 'Sump' Fan, and has a 2 speed switch, so called because it necessitated the removal of the Heater to access the Fan underneath! The 1985 models used the 1082 Fan Assembly as used in the Series 2 Fireplace Inserts.

**\*\*\*NOTE:**

Several different configurations of Door Assemblies were available over the years so please check the Glass size before ordering. Refer page 8.

**COMPLETE PARTS DIAGRAM OPPOSITE**

Engagement Wing

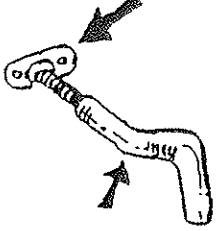

Handle shaft

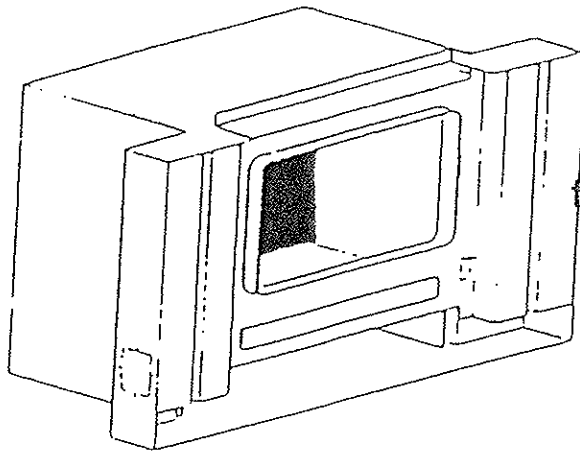

Ash door handle

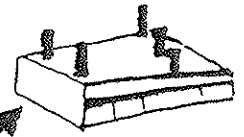

2 or 3 speed switch

Mantel

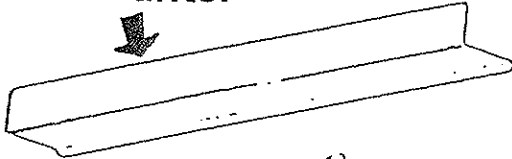

Fan assembly

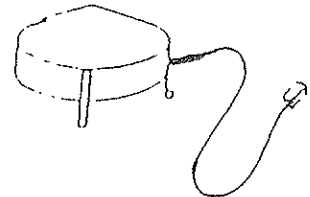

Baffle plate

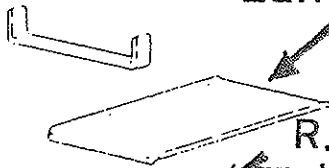

Baffle hangers

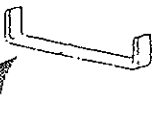

R.H. grate

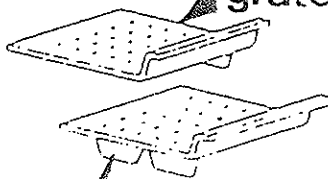

R.H. Liner

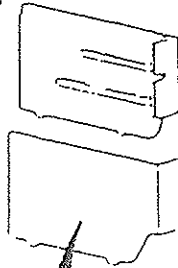

L.H. grate

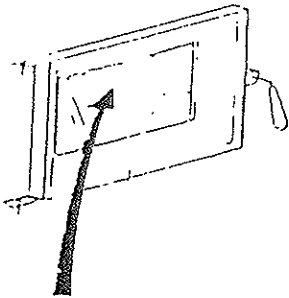

L.H. Liner



Rear Liner

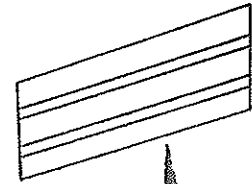

Door glass

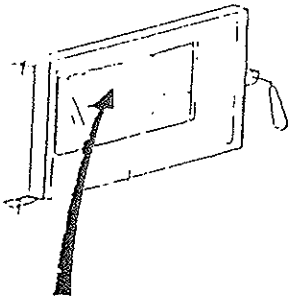

Wooden ash flap handle



Ash pan



Ash door

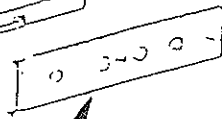

Ash Flap



Bottom Grill

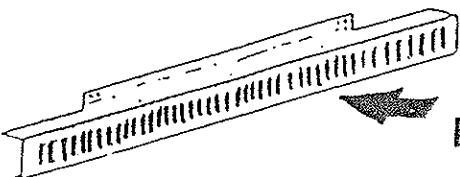

# 2000 SERIES 1 FIREPLACE INSERT 1982 — Late 1985

PART NO.	DESCRIPTION
0026 .....	3 Speed Rotary Switch
0025 .....	2 Speed Switch
1143 .....	Baffle Plate
1142 .....	Baffle Plate Hangers* (See Footnote Below)
1153 .....	Left Hand Grate
1152 .....	Right Hand Grate
1157 .....	Left and Right Hand Grates (Set)
1155 .....	Left Hand Liner
1154 .....	Right Hand Liner
1156 .....	Rear Liner
1082/1930/3 .....	Fan Assembly** (See Footnote Below)
*** .....	Door Glass*** (See Footnote Below)
1013 .....	Handle Engagement Wing
1015 .....	Threaded Handle Shaft
1660 .....	Wooden Handle
1661 .....	Door Handle Bolt
1056 .....	Wooden (Coonara) Ash Flap Handle
1190 .....	Ash Door Handle

**NOTE:**

Some parts for this Heater are not available, i.e. Double Handle versions - Door Handle, Shaft & Engagement Wing.

**\*NOTE:**

Baffle Hangers must be welded in place.

**\*\*NOTE:**

Some early Fans were operated by a variable speed switch which is no longer available. After market variable switches are available such as Arlec or HPM. The Fan Assembly for this model up until 1985 was the 'Sump' Fan, and has a 2 speed switch, so called because it necessitated the removal of the Heater to access the Fan underneath! The 1985 models used the 1082 Fan Assembly as used in the Series 2 Fireplace Inserts.

**\*\*\*NOTE:**

Several different configurations of Door Assemblies were available over the years so please check the Glass size before ordering. Refer page 8.

**COMPLETE PARTS DIAGRAM OPPOSITE**

Engagement Wing

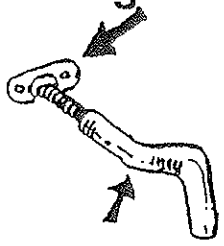

Handle shaft

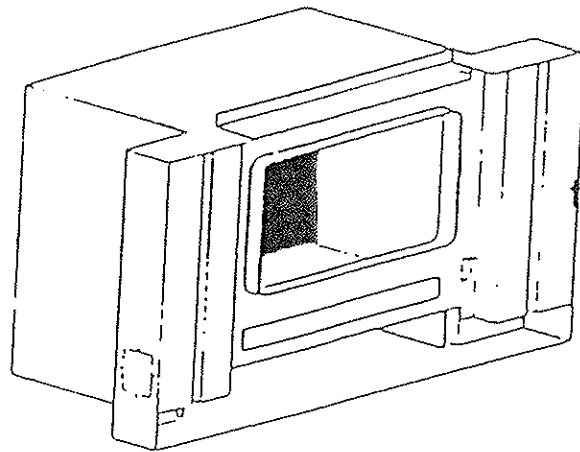

Ash door handle

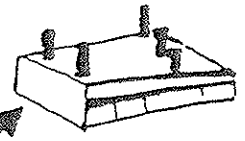

2 or 3 speed switch

Mantel

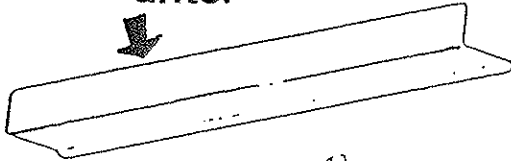

Fan assembly

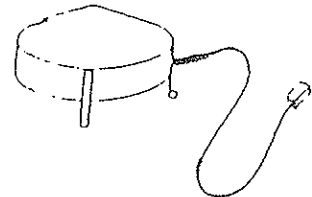

Baffle plate



Baffle hangers

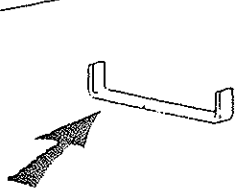

R.H. grate

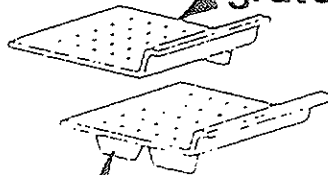

R.H. Liner

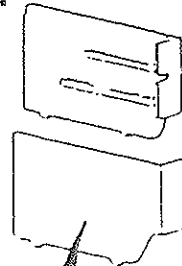

L.H. grate

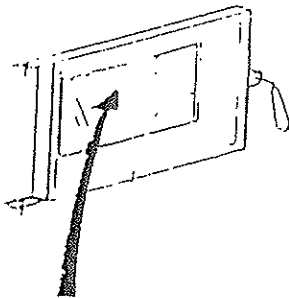

L.H. Liner



Rear Liner



Door glass

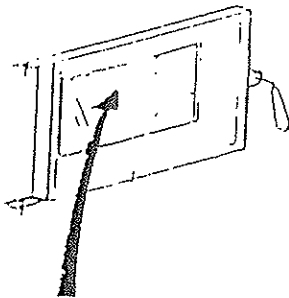

Ash pan

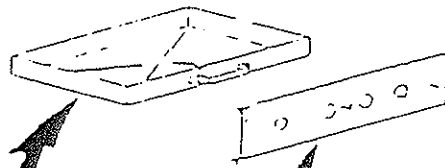

Wooden ash flap handle

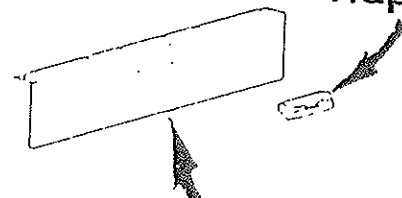

Ash door

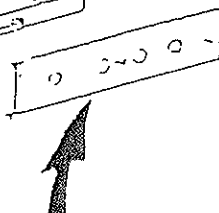

Ash Flap

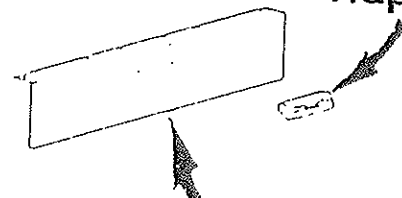

Bottom Grill

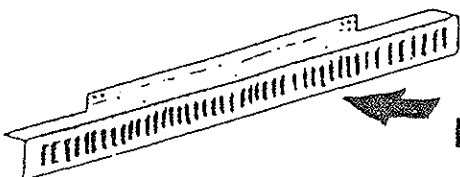



# 1200 SUNSTOVE FREESTANDER 1983 — Mid 1986

<b>PART NO.</b>	<b>DESCRIPTION</b>
0025 .....	2 Speed Rotary Switch
1333 .....	Baffle Plate
1142 .....	Baffle Plate Hangers* (See Footnote Below)
1930 .....	Fan Assembly
1011 .....	Door Glass (Single Handle)
1013 .....	Handle Engagement Wing
1015 .....	Threaded Handle Shaft
1660 .....	Wooden Door Handle
1661 .....	Door Handle Bolt
1335 .....	Fashion Panel

**NOTE:**

Some parts for this Heater are not available

**\*NOTE:**

Baffle Hangers must be welded in place.

**NOTE:**

Check availability of Glass Panels before ordering

**COMPLETE PARTS DIAGRAM OPPOSITE**

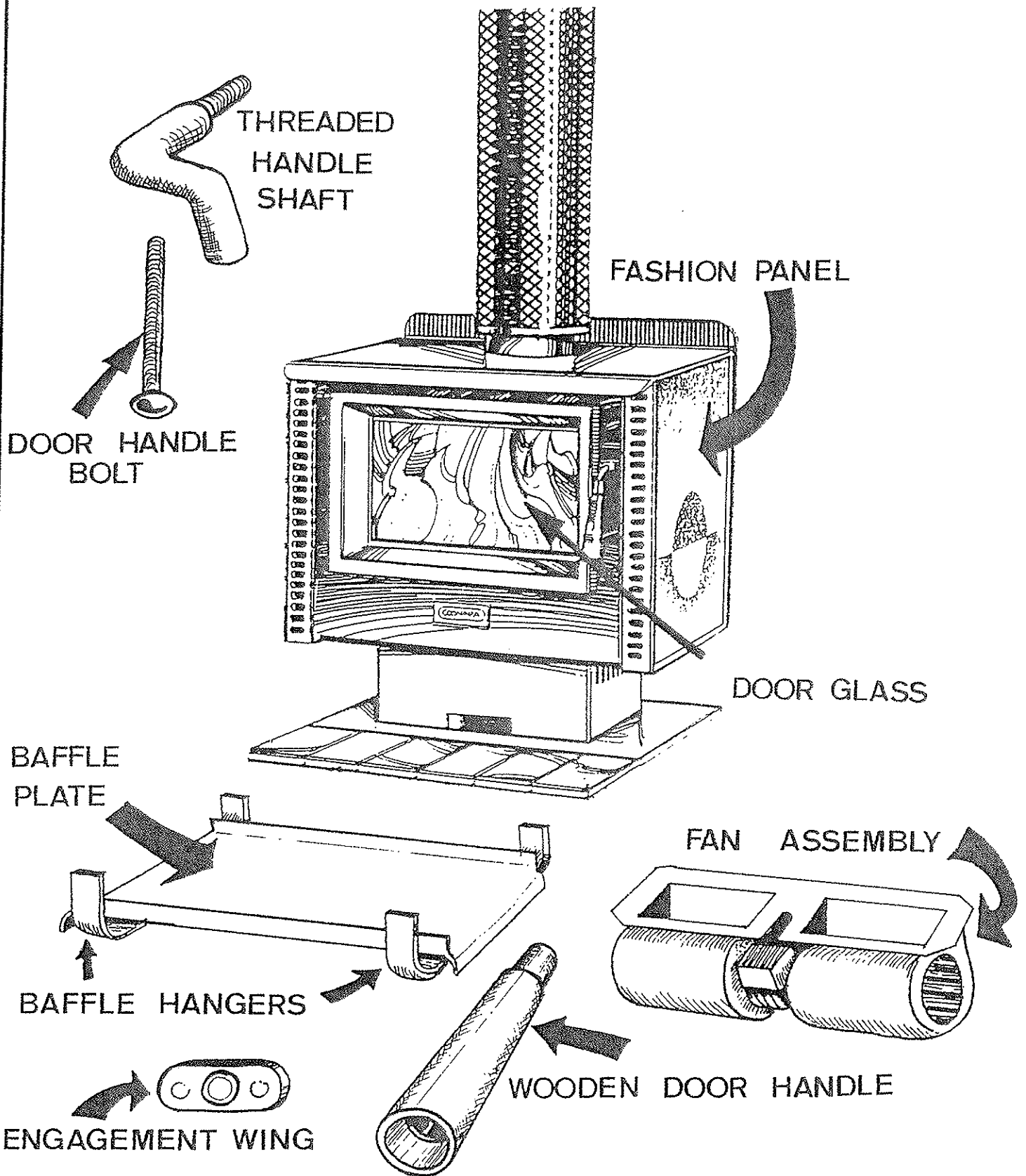

# 1000 SUNSTOVE FREESTANDER 1983 — Mid 1986

<b>PART NO.</b>	<b>DESCRIPTION</b>
0025 .....	2 Speed Rotary Switch
1347 .....	Baffle Plate
1142 .....	Baffle Plate Hangers* (See Footnote Below)
1930 .....	Fan Assembly
1005 .....	Door Glass (Single Handle)
1013 .....	Handle Engagement Wing
1015 .....	Threaded Handle Shaft
1660 .....	Wooden Door Handle
1661 .....	Door Handle Bolt

**NOTE:**

Some parts for this Heater are not available

**\*NOTE:**

Baffle Hangers must be welded in place.

**COMPLETE PARTS DIAGRAM OPPOSITE**

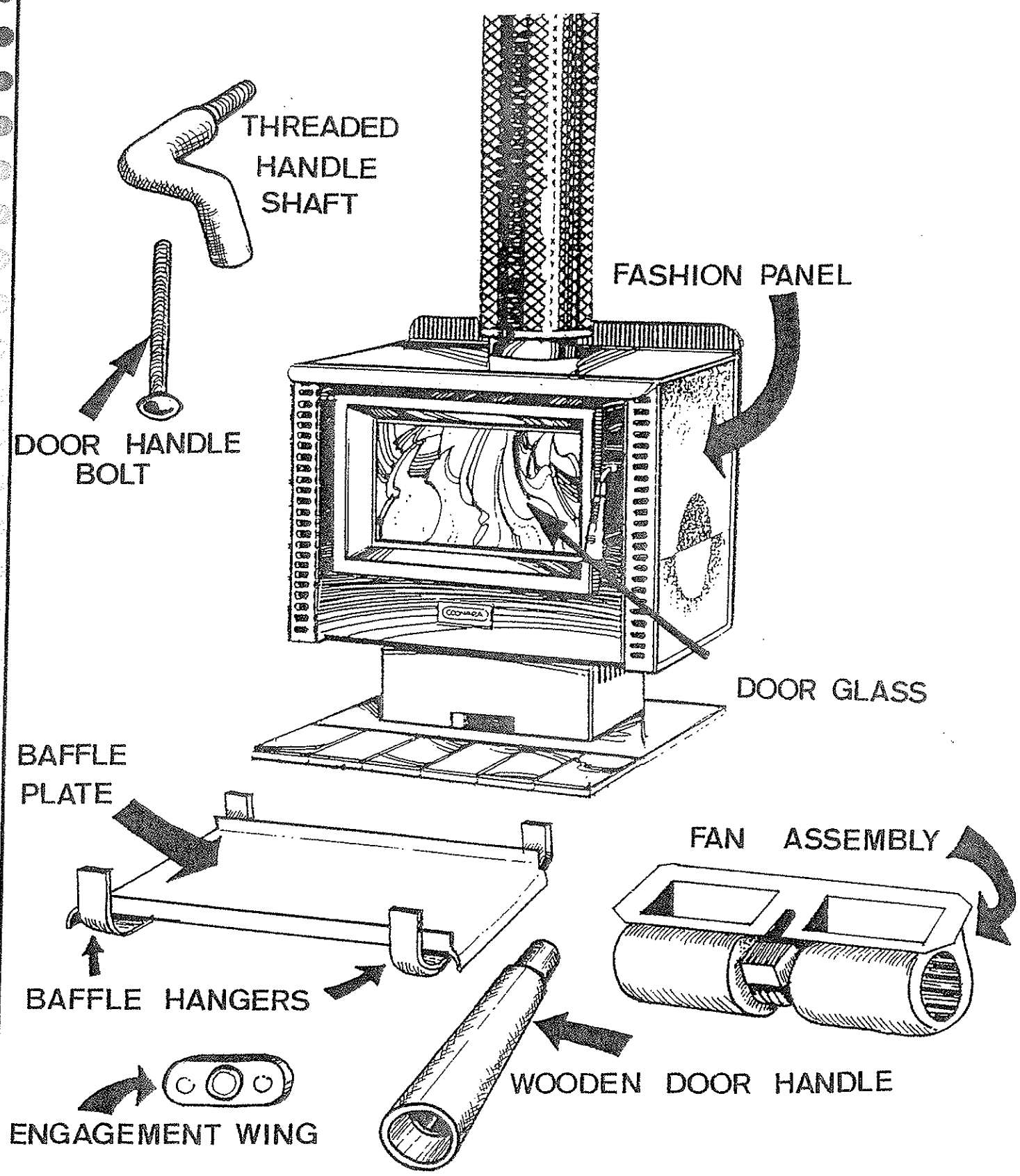

# NIPPA SPARE PARTS

<b>PART NO.</b>	<b>DESCRIPTION</b>
1021 .....	Door Glass Tape
1022 .....	Door Rope
4159 .....	Door Glass
4738 .....	Door Screw & Nut Set
4710 .....	Door Handle Shaft
4155 .....	Door Handle Knob
1522 .....	Door Handle Engagement Wing
1523 .....	Engagement Wing Spacer
0156 .....	Lock Nut 3/8 Whitworth
4724 .....	Door Assembly
4737 .....	Door Hinge Assembly
4703 .....	Baffle Plate
4736 .....	Air Regulating Slide including Shaft and Knob
4153 .....	Air Slide Knob

**COONARA: BCF — NIPPA**  
PARTS LISTING

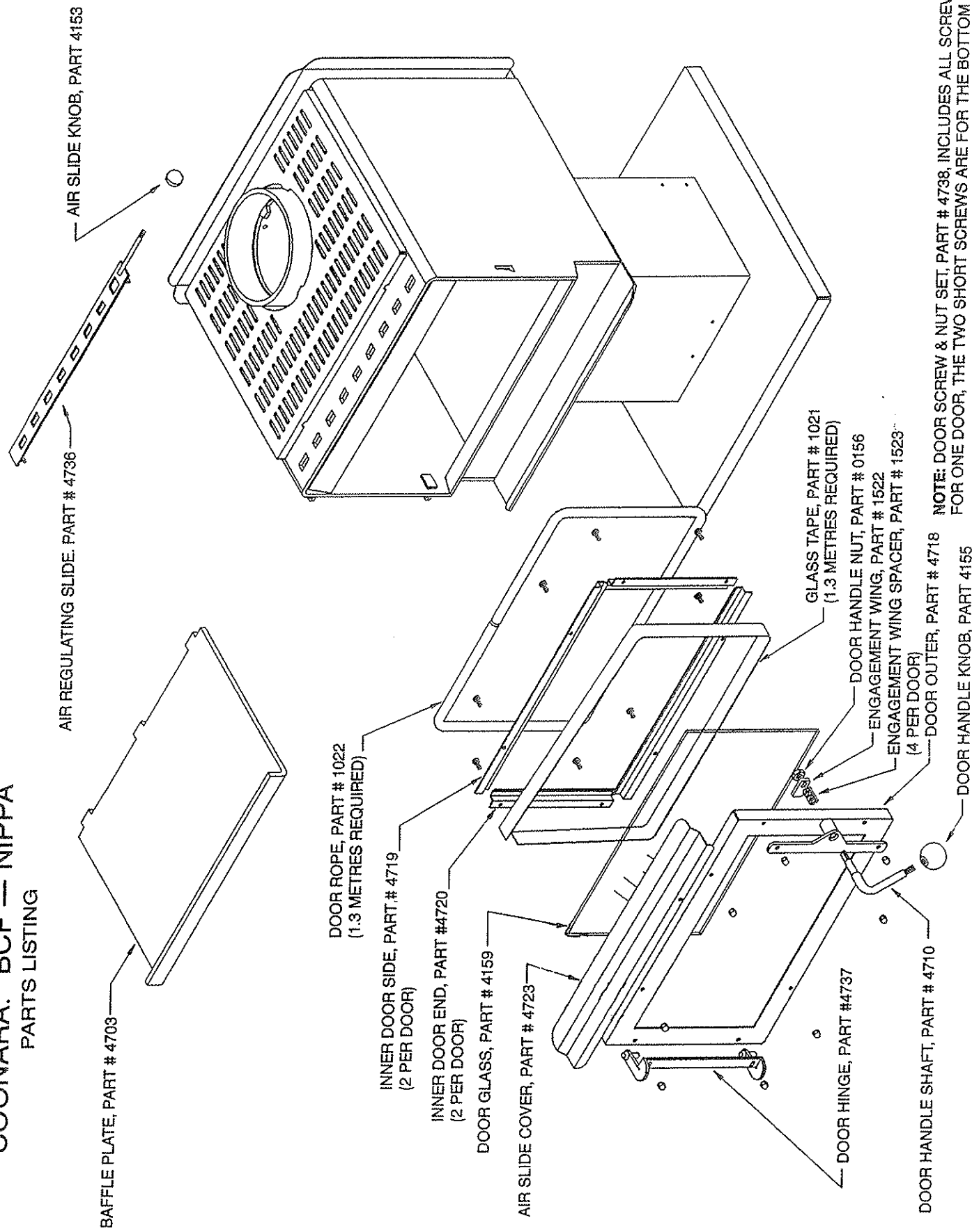
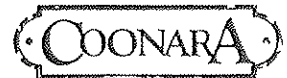

**NOTE:** DOOR SCREW & NUT SET, PART # 4738, INCLUDES ALL SCREWS & NUTS FOR ONE DOOR, THE TWO SHORT SCREWS ARE FOR THE BOTTOM OF THE DOOR.  
ALSO AVAILABLE, COMPLETE DOOR ASSEMBLY, PART # 4724

# INBUILT MODELS - EXTENSION PANELS

FOR USE WHERE FIREPLACE HEIGHT AND WIDTH IS GREATER THAN THE HEATER

**CCI**

Part Number 4173

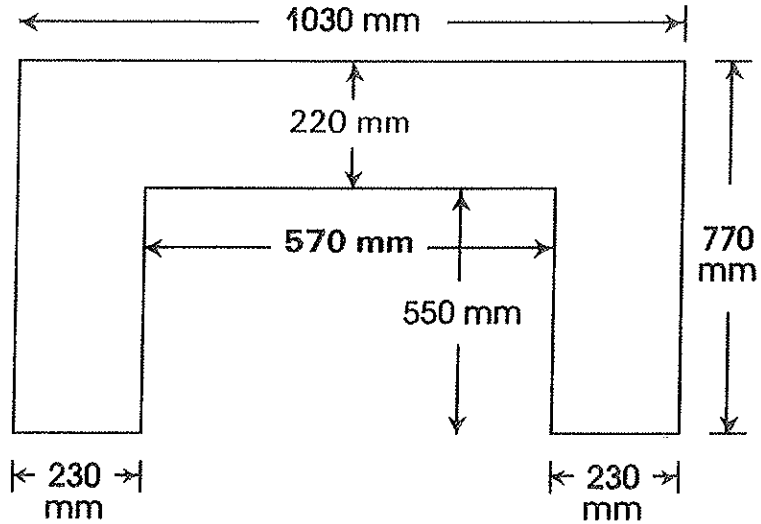

**CMI**

Part Number 4334

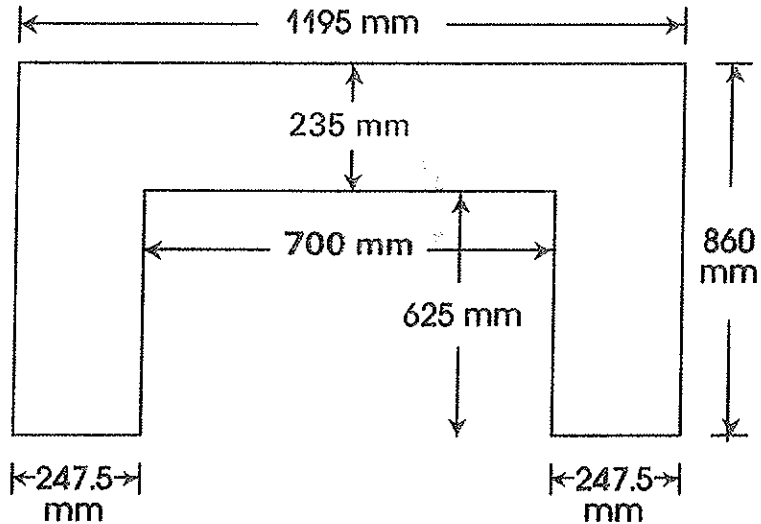

**CLI**

Part Number 4262

